

Introduction to Physical Properties

Alberto Malinverno

Well Logging Principles and Applications
G9947 - Seminar in Marine Geophysics
Spring 2008

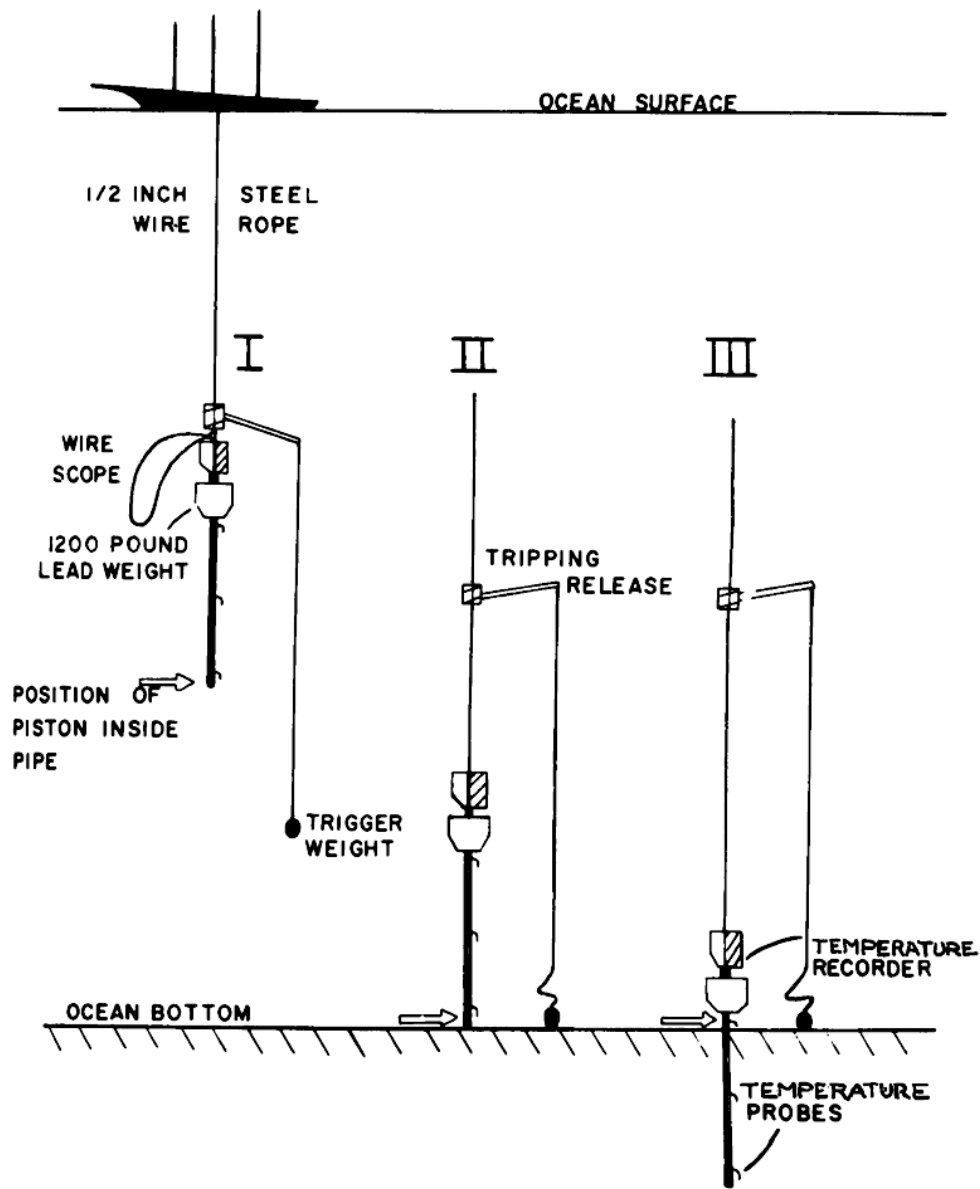



Ewing piston corer works like a hand pump. As the tube falls, the plunger inside sucks in the mud.

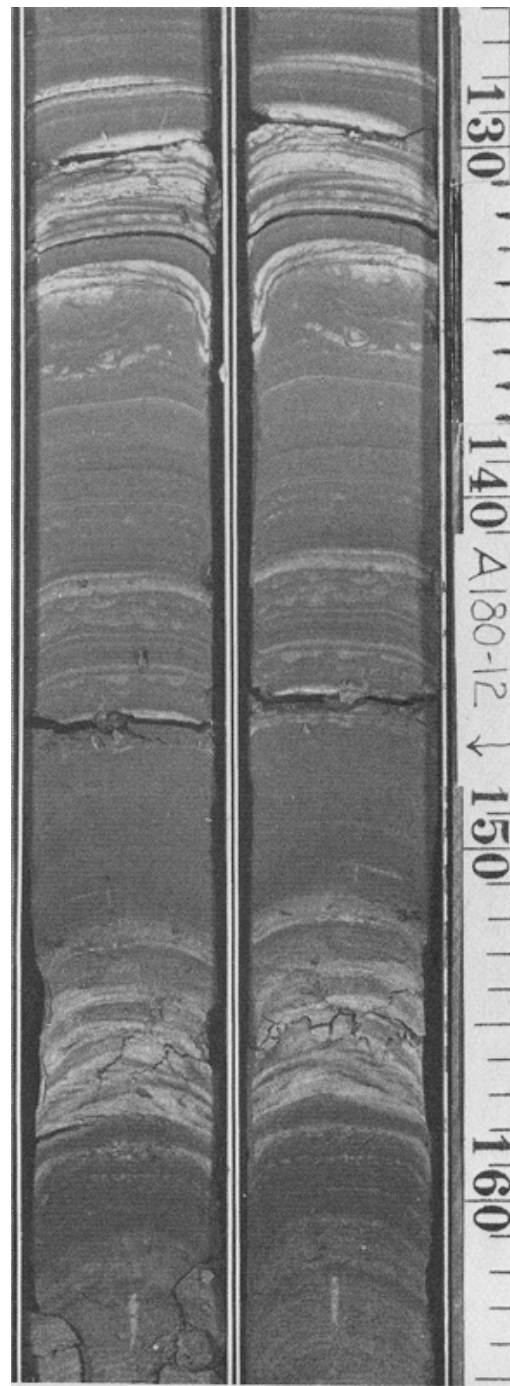

A ROTARY RIG

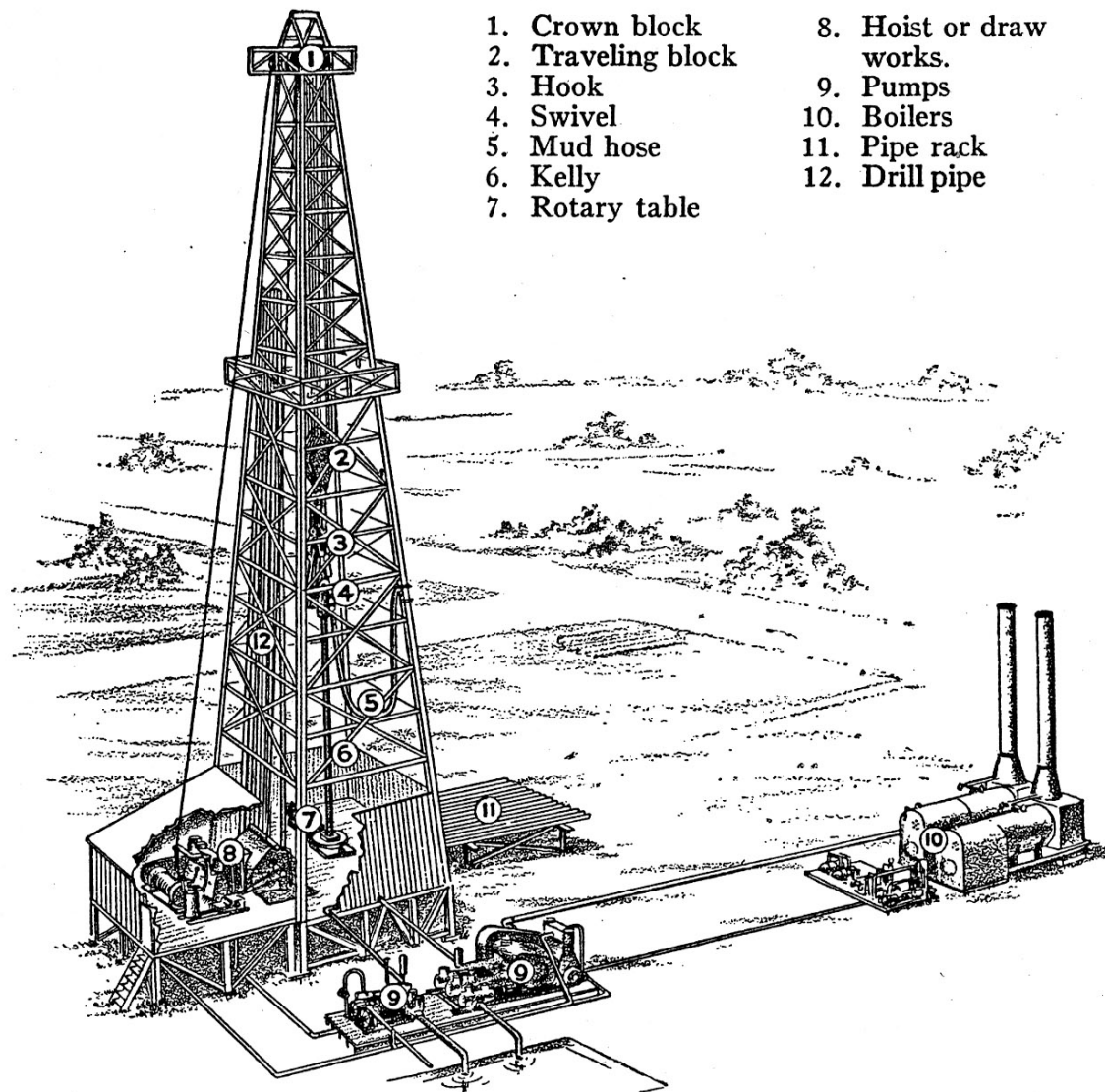

Rotary drilling bores a hole by rotating a bit on the end of a string of pipe, called drill pipe, some of which is shown standing in the derrick ready to be "run in" to the hole. The draw works at the left is the mechanism that runs most of the job. The pumps in the foreground force mud down through the drill pipe and back up between the drill pipe and the wall of the hole, flushing out the cuttings and plastering the wall of the hole so that it will not cave.

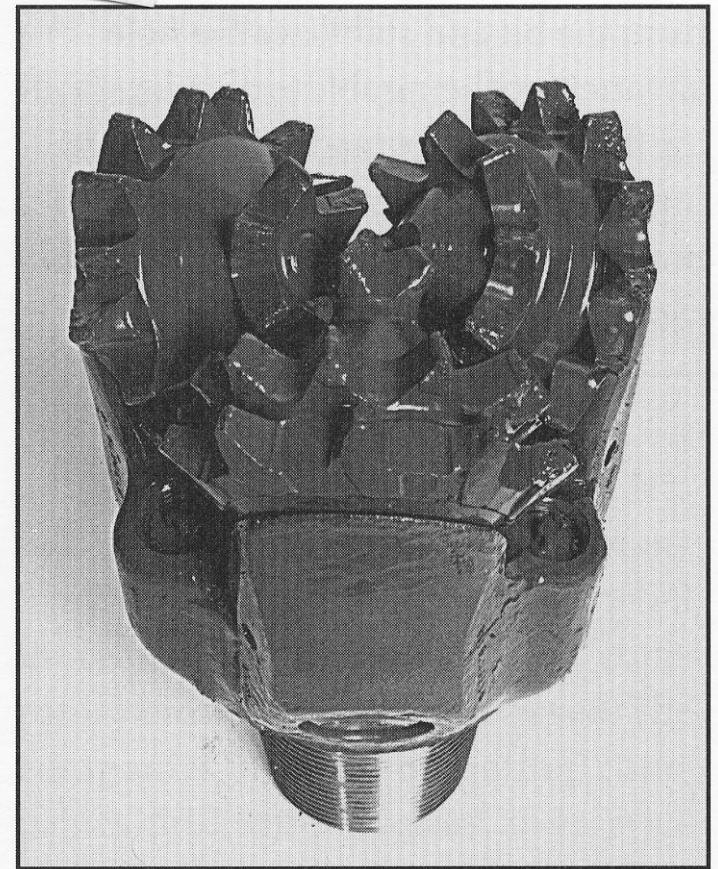
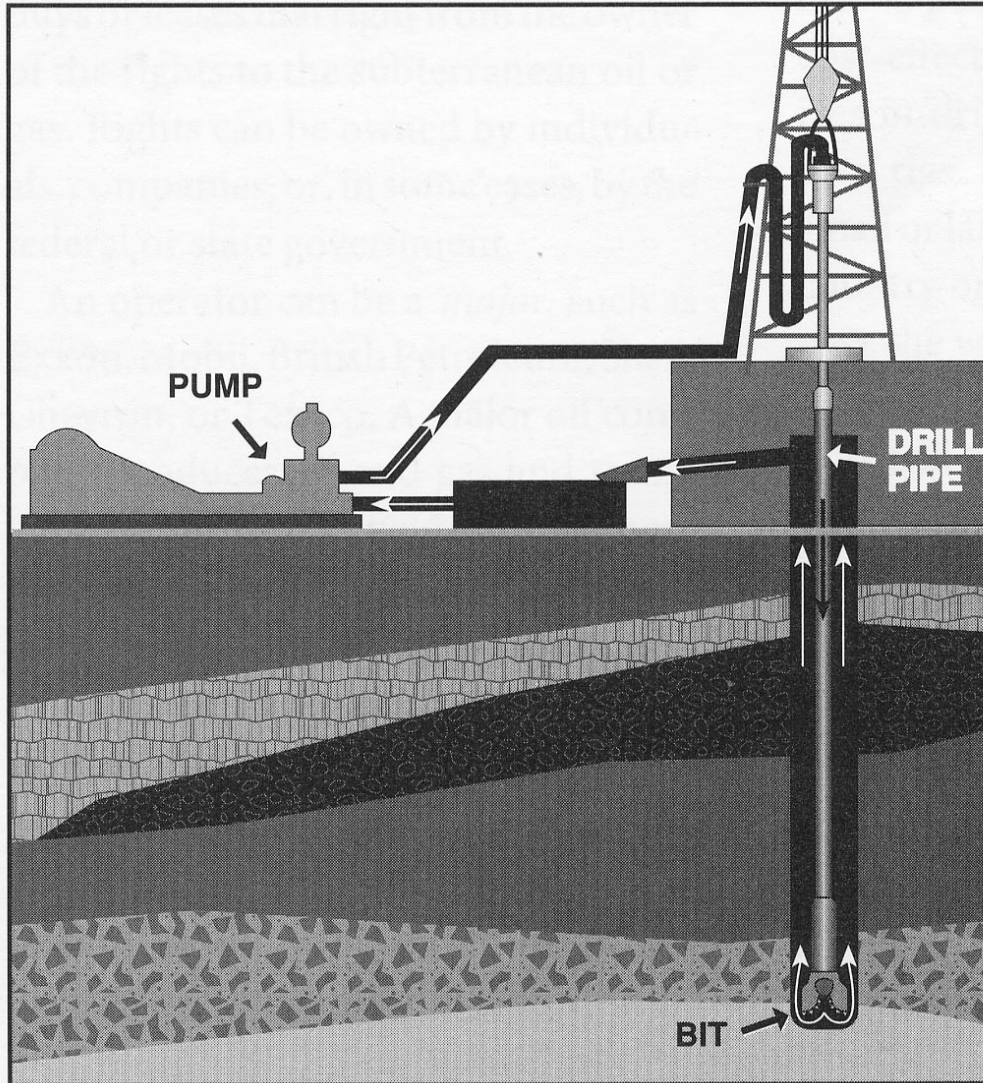
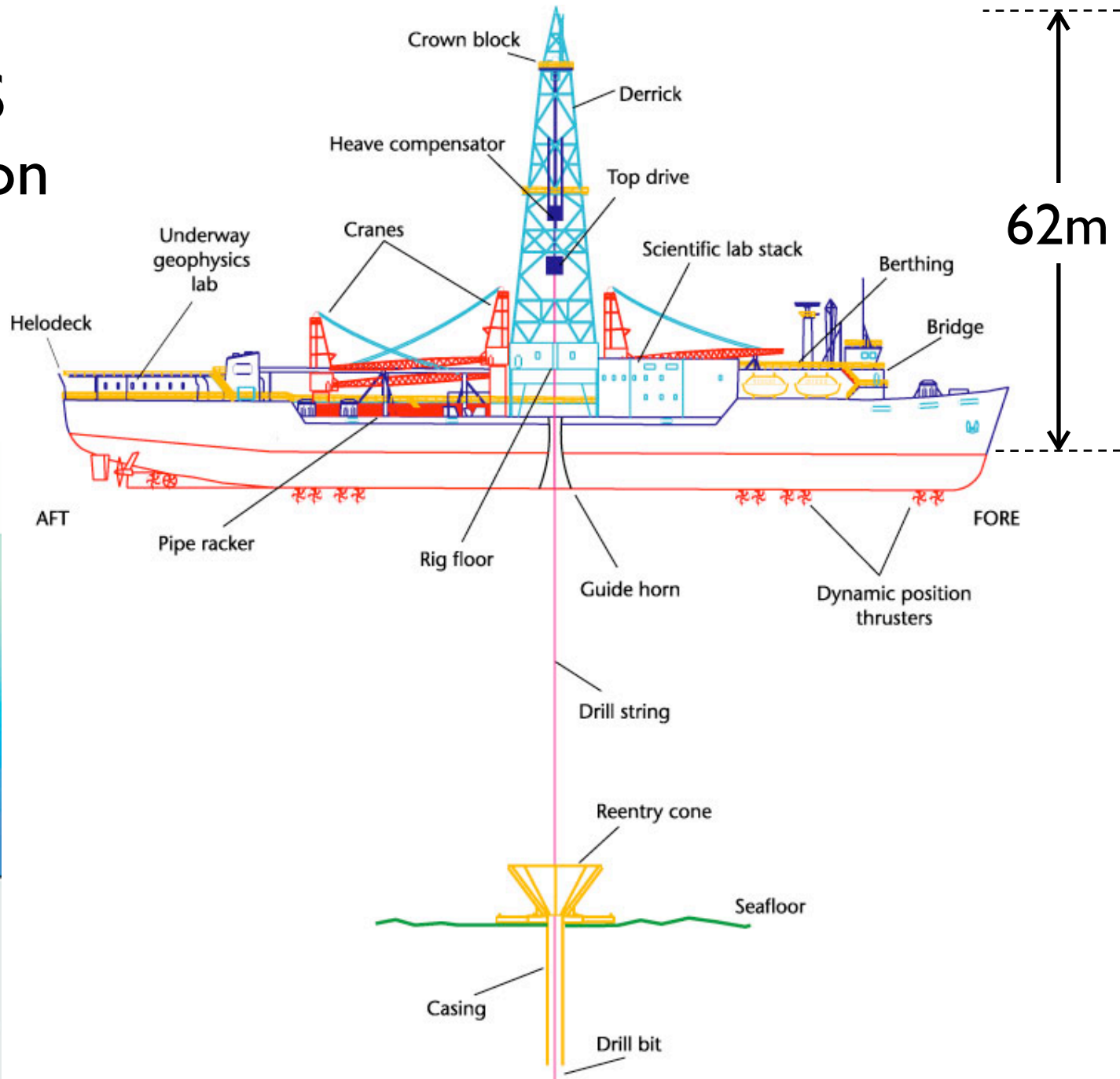

Figure 6. The cutters on this bit are steel teeth.

Figure 7. A pump circulates drilling mud down the drill pipe, out the bit, and up the hole.

JOIDES Resolution



Non-riser

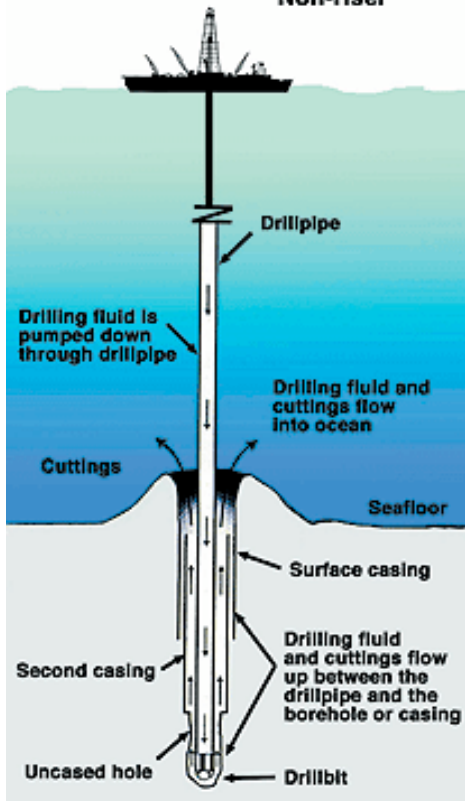

ROTARY SPECIAL EQUIPMENT

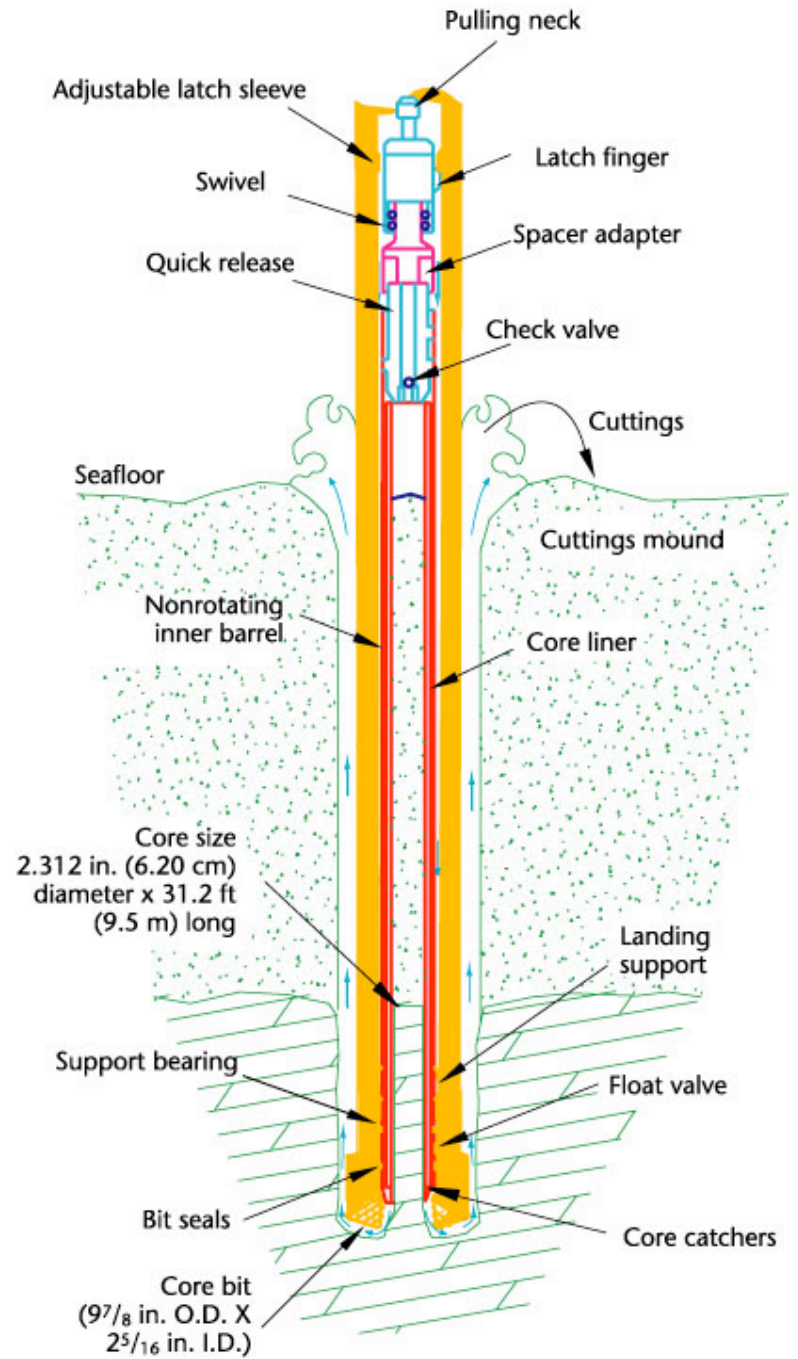
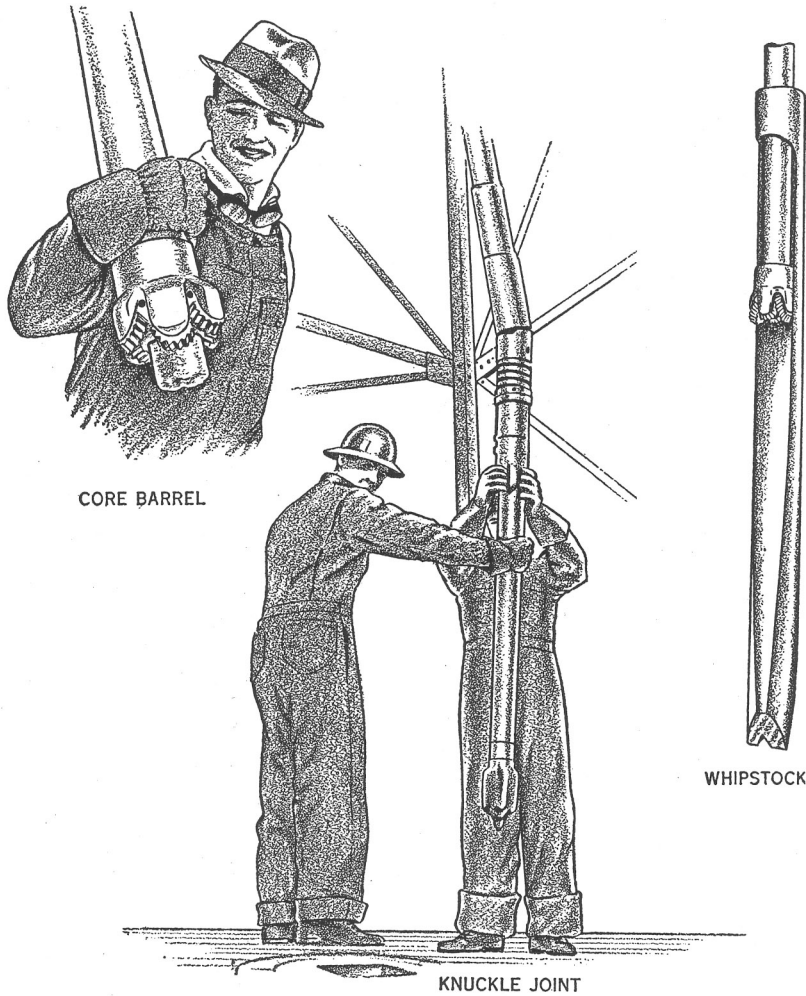

When the operator wants to know the exact character of the rocks he is drilling he uses a core barrel and takes a core which his geologist or micro-paleontologist or micro-mineralogist or chemist can study. When he wants to divert his hole from the vertical he uses a whipstock or knuckle joint.

Multisensor track (MST)

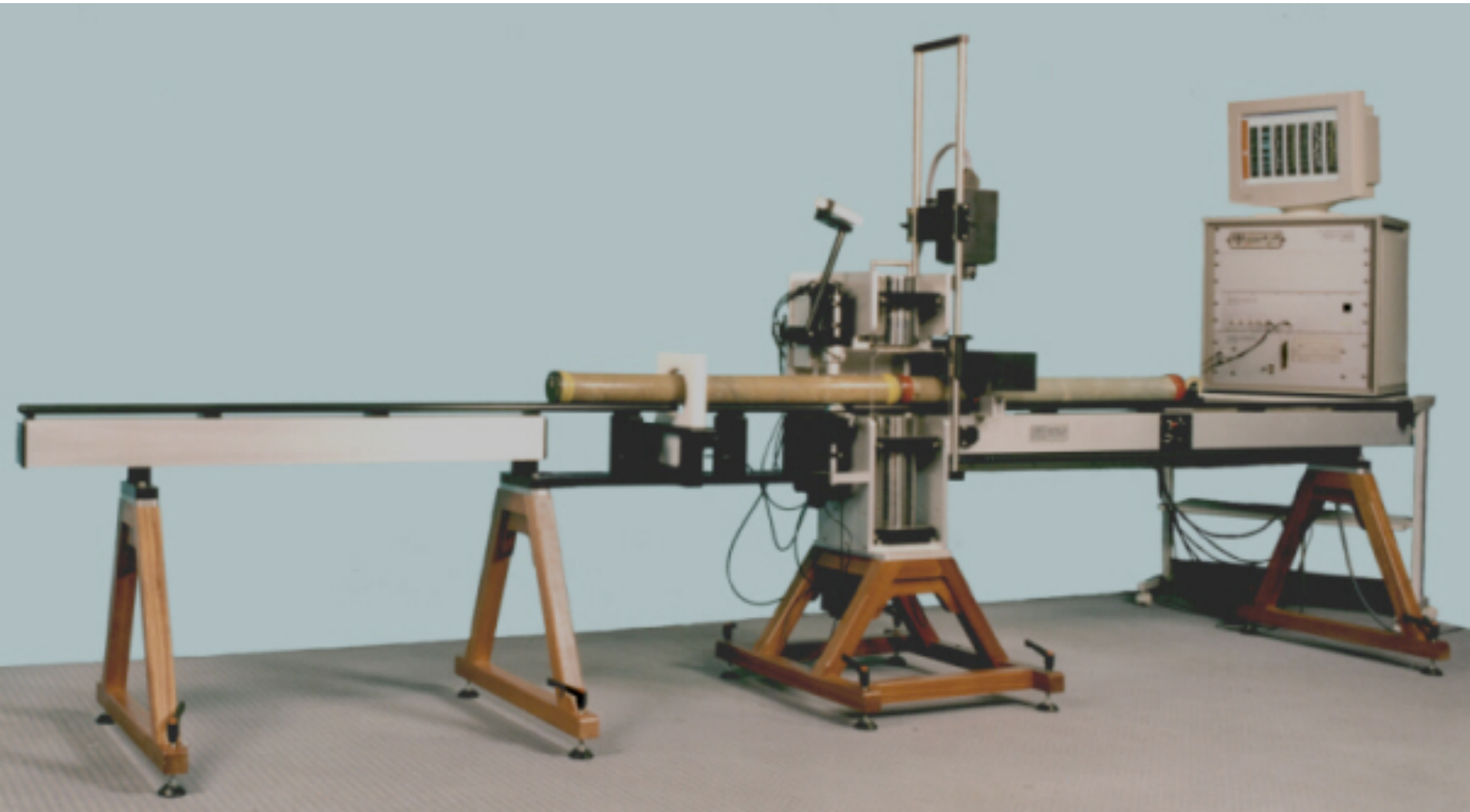

Physical properties

- Index properties (density, porosity)
- Permeability
- Natural radioactivity
- Electrical
- Magnetic
- Spectral reflectance (color)
- Elastic / acoustic

Applications

- Sediment composition
 - Biogenic vs. terrigenous
 - Mineralogy of terrigenous fraction
- Texture
 - Grain size
 - Compaction
 - Rigidity (grain-grain contact, cementation)
 - Water content and fluid flow

Physical properties as proxies

- What we want to know may be hard to measure
- Non-destructive, fast, high-resolution
- Examples
 - Density, P-velocity: CaCO_3 % estimate
 - Natural radioactivity: clay content and clay mineralogy
 - Magnetic susceptibility: Terrigenous %
 - Spectral reflectance: CaCO_3 , C_{org} %, terrigenous mineralogy

Index properties

- Water content = wet weight / dry weight
- Wet bulk density = wet weight / wet volume
- Dry bulk density = dry weight / dry volume
- Grain density
 - Calcite 2.71 g/cc
 - Quartz 2.65 g/cc
 - Terrigenous clays ~1.8-2.2 g/cc
 - Opal ~1.4 g/cc
 - Water ~1 g/cc
- Porosity = Pore volume / total volume

$$\phi = \frac{\text{Pore volume}}{\text{Total volume}}$$

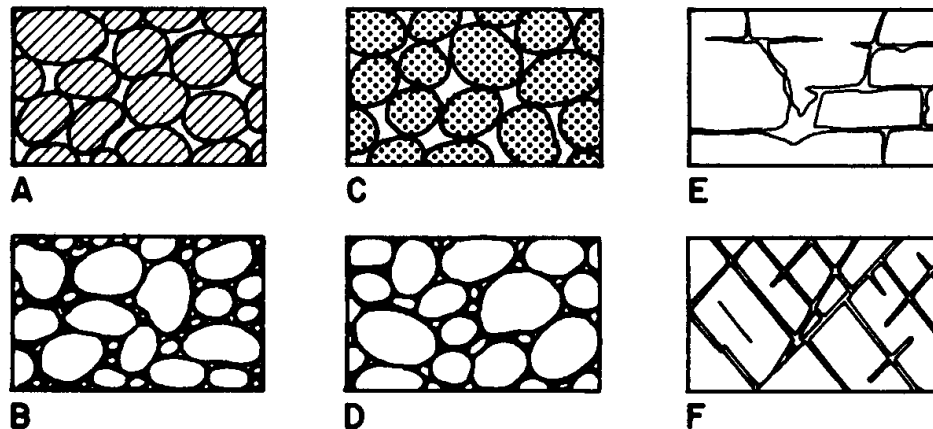
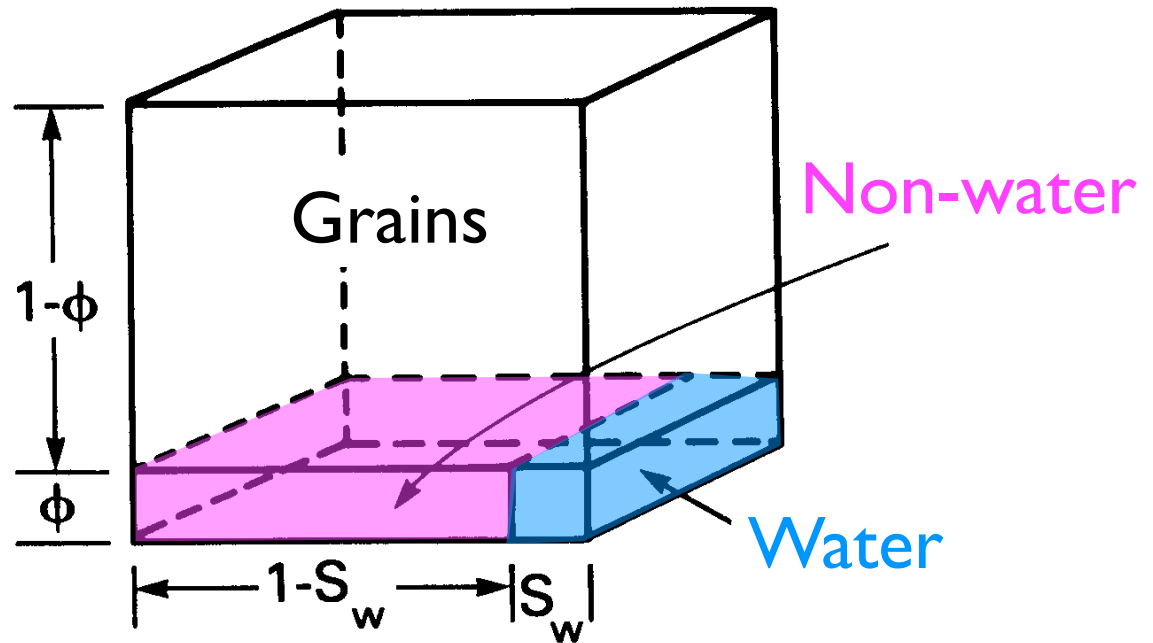
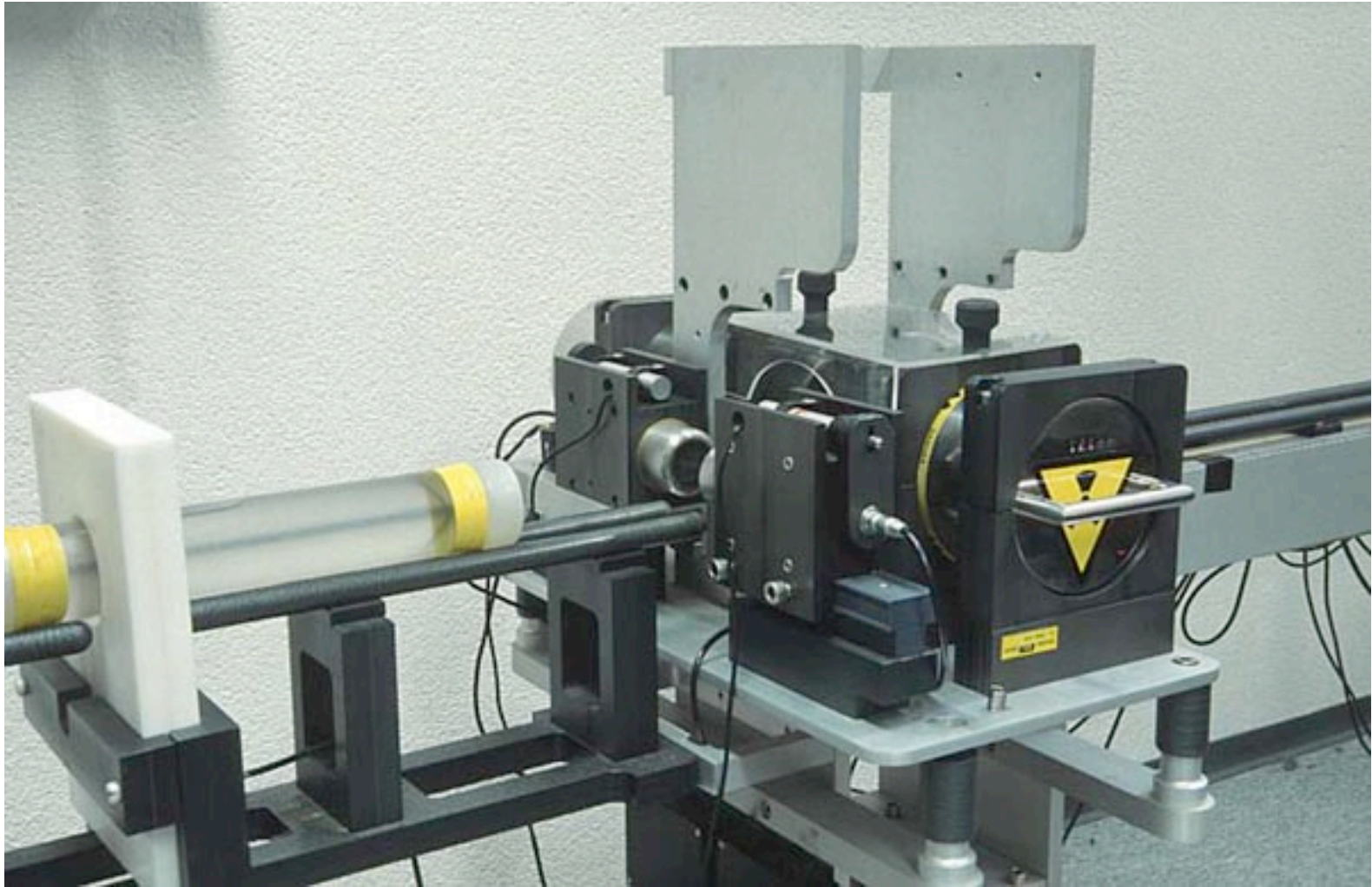

FIG. 1.1.1. Diagram showing several types of Rock Interstices. A. Well-sorted sedimentary deposit having high porosity; B. Poorly sorted sedimentary deposit having low porosity; C. Well-sorted sedimentary deposit consisting of pebbles that are themselves porous, so that the deposit as a whole has a very high porosity; D. Well-sorted sedimentary deposit whose porosity has been diminished by the deposition of mineral matter in the interstices; E. Rock rendered porous by solution; F. Rock rendered porous by fracturing. (After Meinzer, 1942.)

Wet bulk density measurement



^{137}Ce source gamma-ray attenuation porosity evaluator (GRAPE)

Density and CaCO₃ %

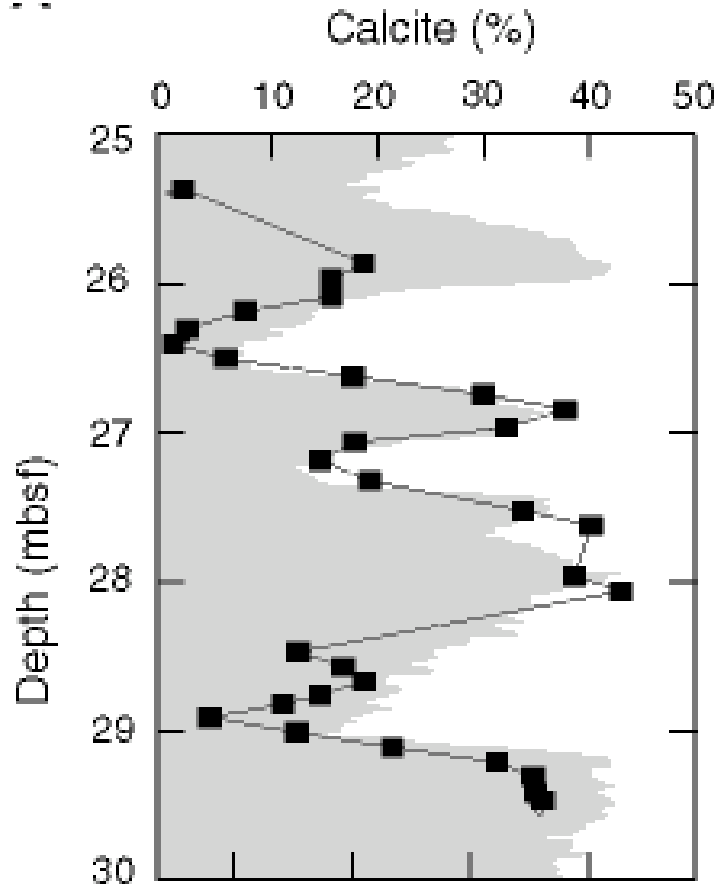

ODP Leg 172 (BBOR)

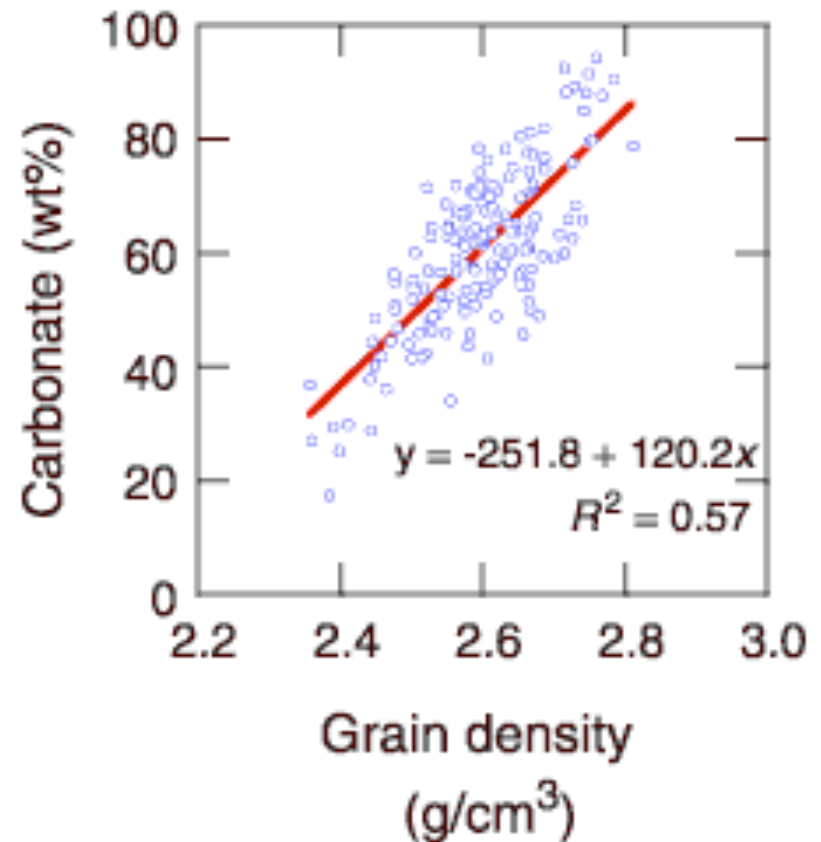

ODP Site 1238 (SE Pacific)

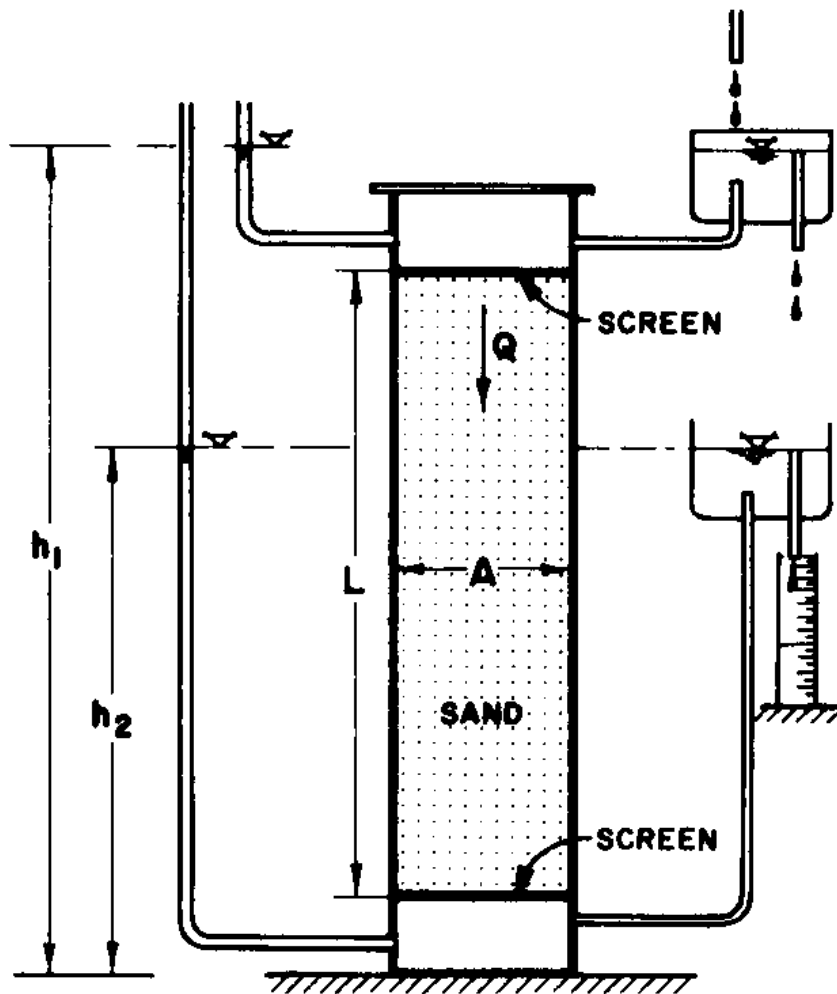

FIG. 5.1.1. Darcy's experiment.

$$Q = K \frac{A(h_1 - h_2)}{L}$$

Q is flow rate [L^3/T]

K is hydraulic conductivity [L/T]

$$K = k \frac{\rho g}{\mu}$$

k is permeability [L^2]

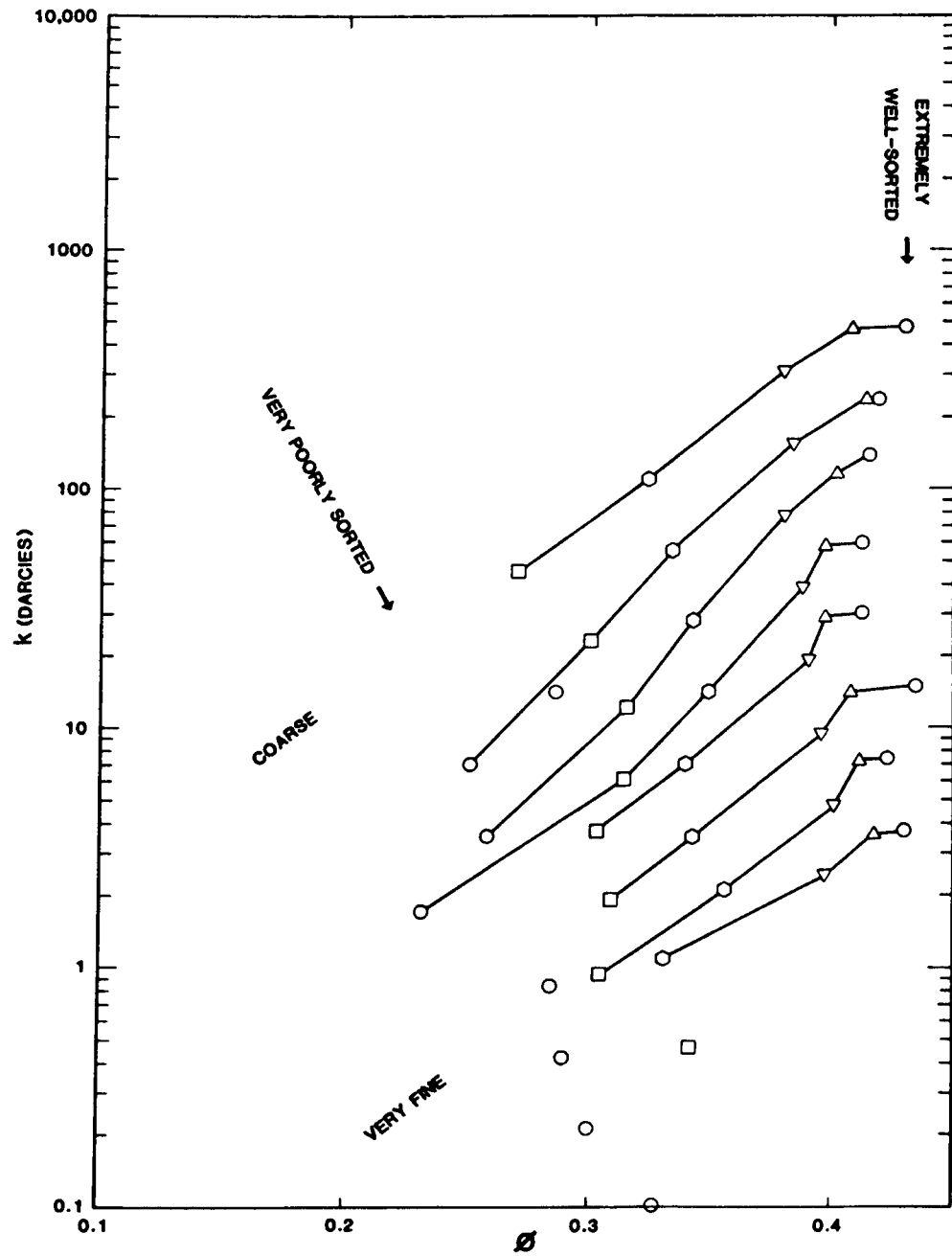

Figure 15.2 Permeability-porosity data from unconsolidated artificial sand packs by Beard and Weyl (1973). Symbols distinguish sorting groups; lines connect grain size ranges. (Nelson, 1994)

Random close packing of hard spheres and disks

James G. Berryman

Lawrence Livermore National Laboratory, P.O. Box 808, L-200, Livermore, California 94550

(Received 30 July 1982)

A simple definition of random close packing of hard spheres is presented, and the consequences of this definition are explored. According to this definition, random close packing occurs at the minimum packing fraction η for which the median nearest-neighbor radius equals the diameter of the spheres. Using the radial distribution function at more dilute concentrations to estimate median nearest-neighbor radii, lower bounds on the critical packing fraction η_{RCP} are obtained and the value of η_{RCP} is estimated by extrapolation. Random close packing is predicted to occur for $\eta_{\text{RCP}}=0.64\pm 0.02$ in three dimensions and $\eta_{\text{RCP}}=0.82\pm 0.02$ in two dimensions. Both of these predictions are shown to be consistent with the available experimental data.

I. INTRODUCTION

Packings of spheres with equal radii have been studied for many years¹ because they serve as useful models for a variety of physical systems. Perhaps the most extensive literature on this subject has arisen in studies of the molecular nature of fluids, glasses, and amorphous materials.²⁻⁵ But this subject is equally fundamental to studies of the macroscopic, granular nature of powders and porous materials.⁶⁻⁸

The three special packing models which are most

they generally fall in the range $\eta \sim 0.82-0.89$.

Although the experimental numbers for random packings in three dimensions are reasonably well known, a precise definition of random close packing is still lacking.¹⁴ The process of arriving at a meaningful definition of random close packing is further complicated by the common desire to identify the critical packing fraction η_{RCP} with particular thermodynamic features of some other physical system to be modeled, e.g., singularities in the equation of state for a hard-sphere fluid along the supercooled metastable fluid branch.¹⁵⁻¹⁷ Although such ther-

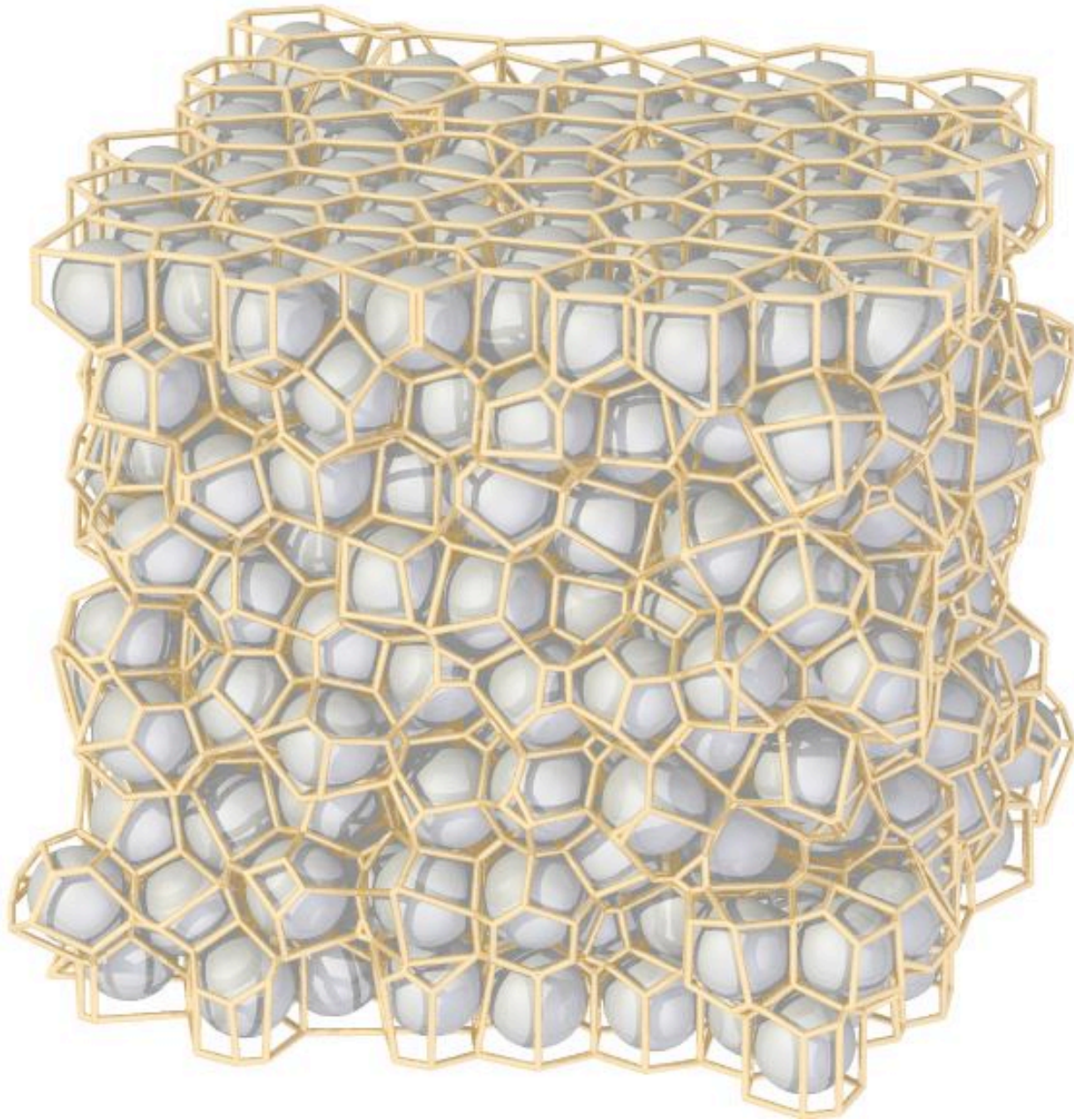

Random close
packing of
spheres:
density ≈ 0.64 ,
porosity ≈ 0.36

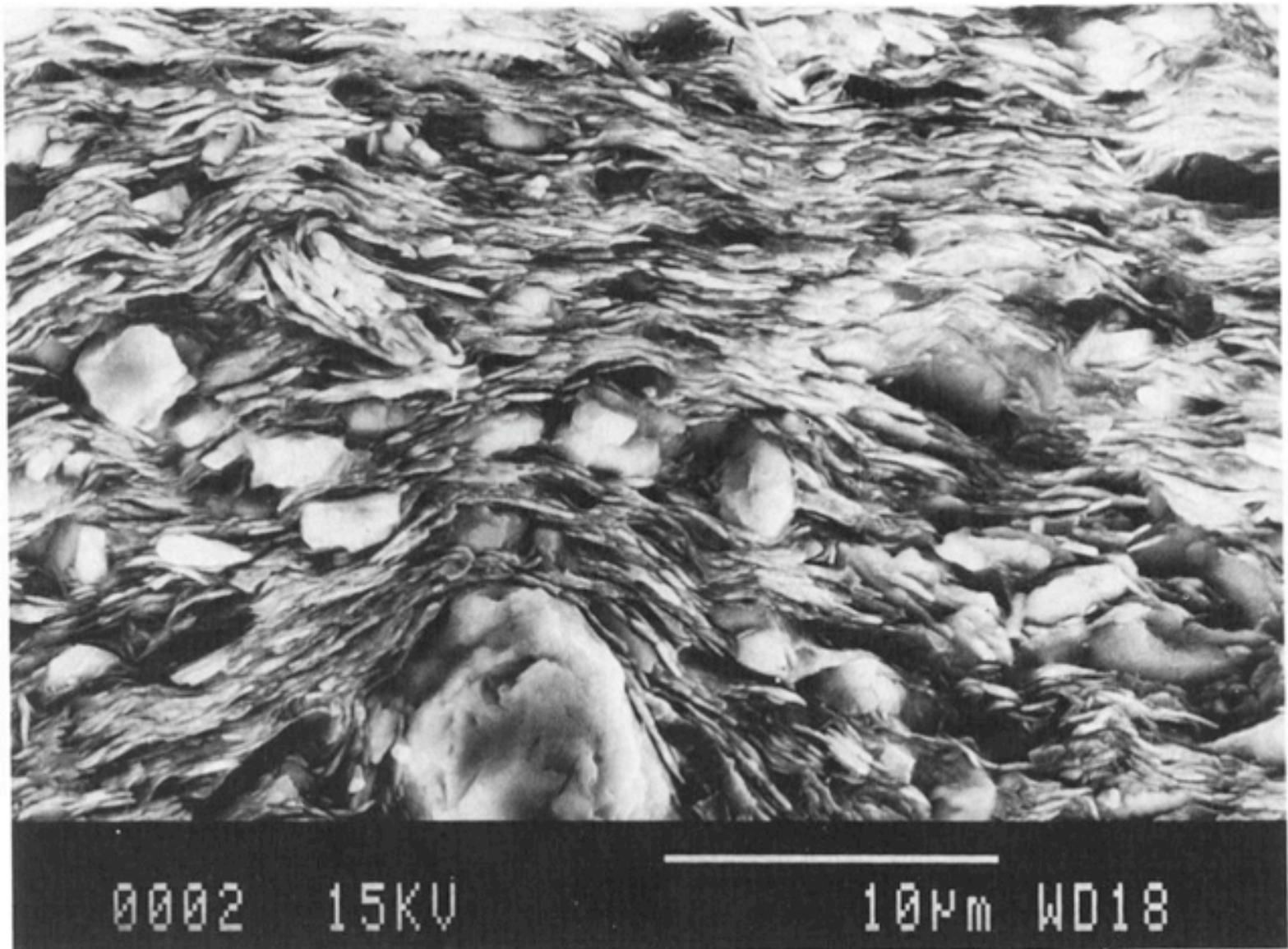
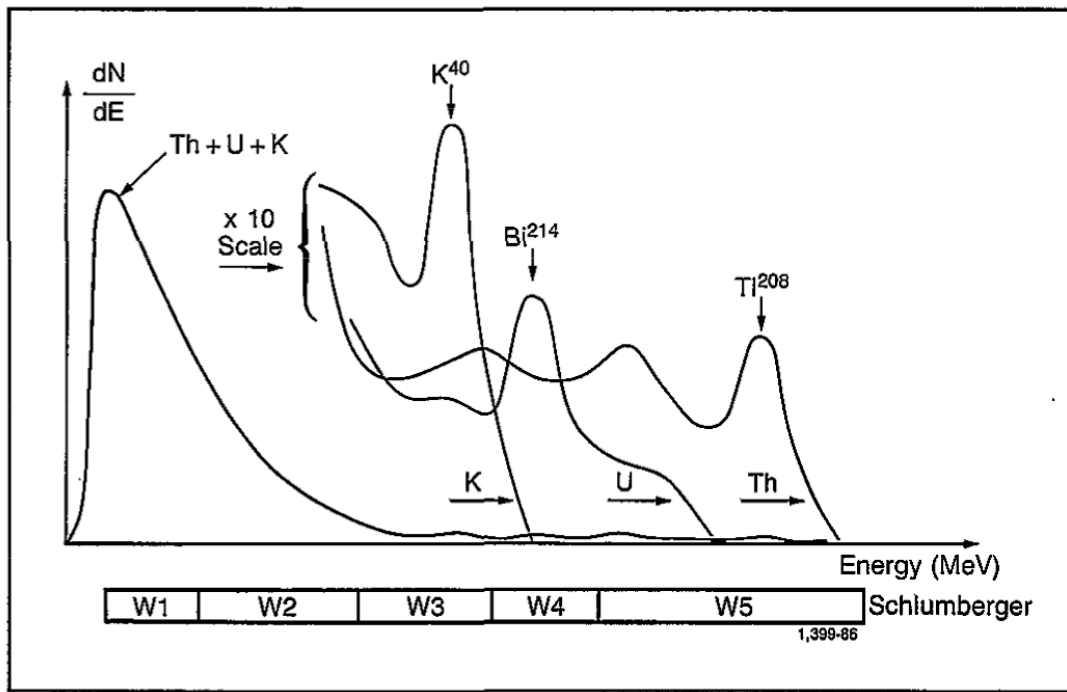

FIG. 1. Scanning electron microphotograph of a shale. The platey particles are clay minerals while the larger, nearly spherical, particles are silt.

Natural gamma ray

- Naturally radioactive elements: K, U, Th
- Gamma rays have distinctive energy spectra



K: high in illite

Th: high in clays

U: high in C_{org}-rich sediments

Fig. 3-9—Potassium, thorium, and uranium response curves (NaI crystal detector).

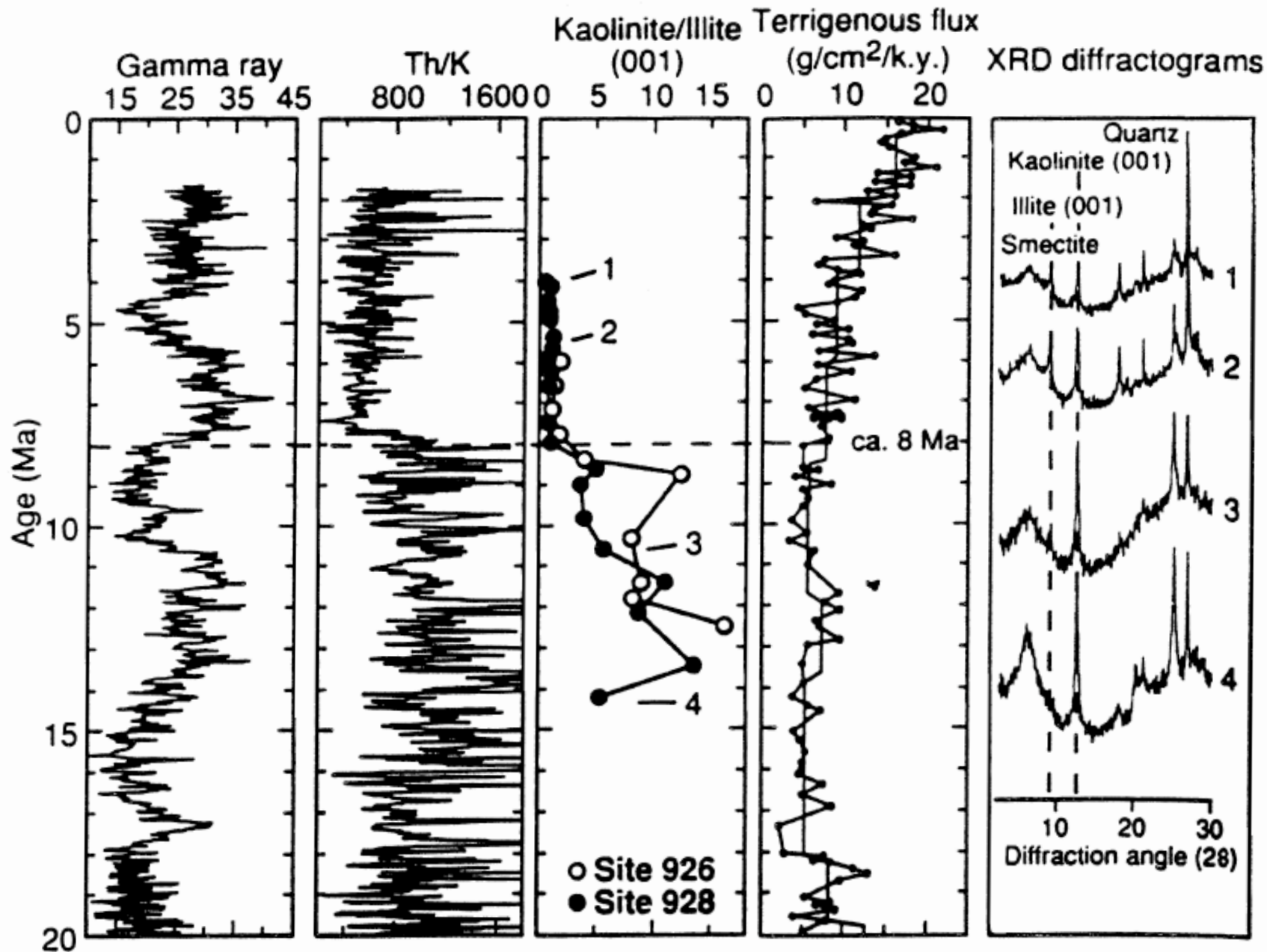

ODP Leg 154 - Ceara Rise

Electrical properties

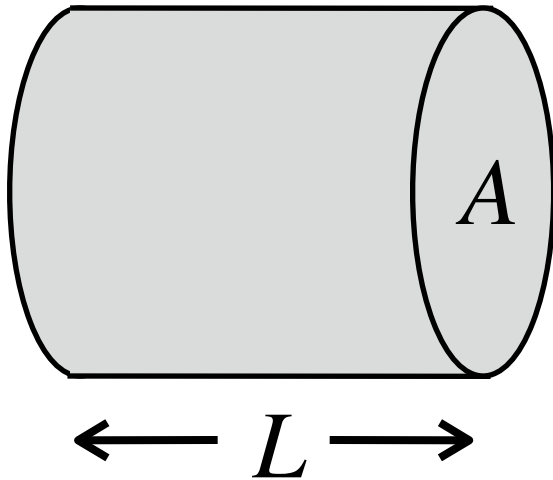

Ohm's law

$$V = IR^*$$

Resistance R^*

Resistivity R

$$R^* = R \frac{L}{A}$$

Units of resistivity are $\Omega \cdot \text{m}$ (ohm·m)

TABLE III. Electrical Resistivities of Earth Materials

Material	Resitivity (Ω m at 18–20°C)
Pure Materials^a	
Marble	$5 \times 10^7 - 10^9$
Mica	$10^{11} - 10^{14}$
Quartz	1×10^{12}
Quartz \perp	3×10^{14}
Slate	$1 - 2 \times 10^6$
Sulfur	$10^{14} - 10^{15}$ temperature unknown
Petroleum	2×10^{14} temperature unknown
Distilled water	0.5×10^4
Salt Water at 15°C ^b (kppm NaCl)	
2	3.4
10	0.72
20	0.38
100	0.09
200	0.06
Typical Formations^c	
Clay/shale	2–10
Saltwater sands	0.5–10
Oil sands	$5 - 10^3$
Compact limestone	10^3
Dolomite	10^3
Lignite	10^2

^a “Handbook of Chemistry and Physics,” 38th Ed., pp. 2237–2238. Chemical Rubber Publishing Co., Cleveland, 1956.

^b R. Desbrandes, “Diagraphies dans les Sondages,” p. 124. Éditions Technip, Paris, France, 1982.

^c R. Desbrandes, “Théorie et Interprétation des Diagraphies,” p. 8. Éditions Technip, Paris, France, 1968.

The electrical resistivity of rocks in the upper portion of the earth’s crust varies with:

1. Water content. Natural waters are much more conductive than most rock-forming minerals.
2. Salinity. Natural waters are conductive in proportion to the concentration of ionized salts in the water.
3. Temperature. A rock at a depth of 1 km can be twice as conductive as the same rock at the surface because water conductivity increases with temperature.
4. Clays and conductive minerals. Clays can augment the ionic conduction of pore water. Electronic conduction in sulfide and oxide minerals can dominate if such minerals are sufficiently abundant.
5. Geologic strike of the formation. Many sedimentary and metamorphic rocks are anisotropic; they have a lower resistivity along the bedding plane than perpendicular to it.

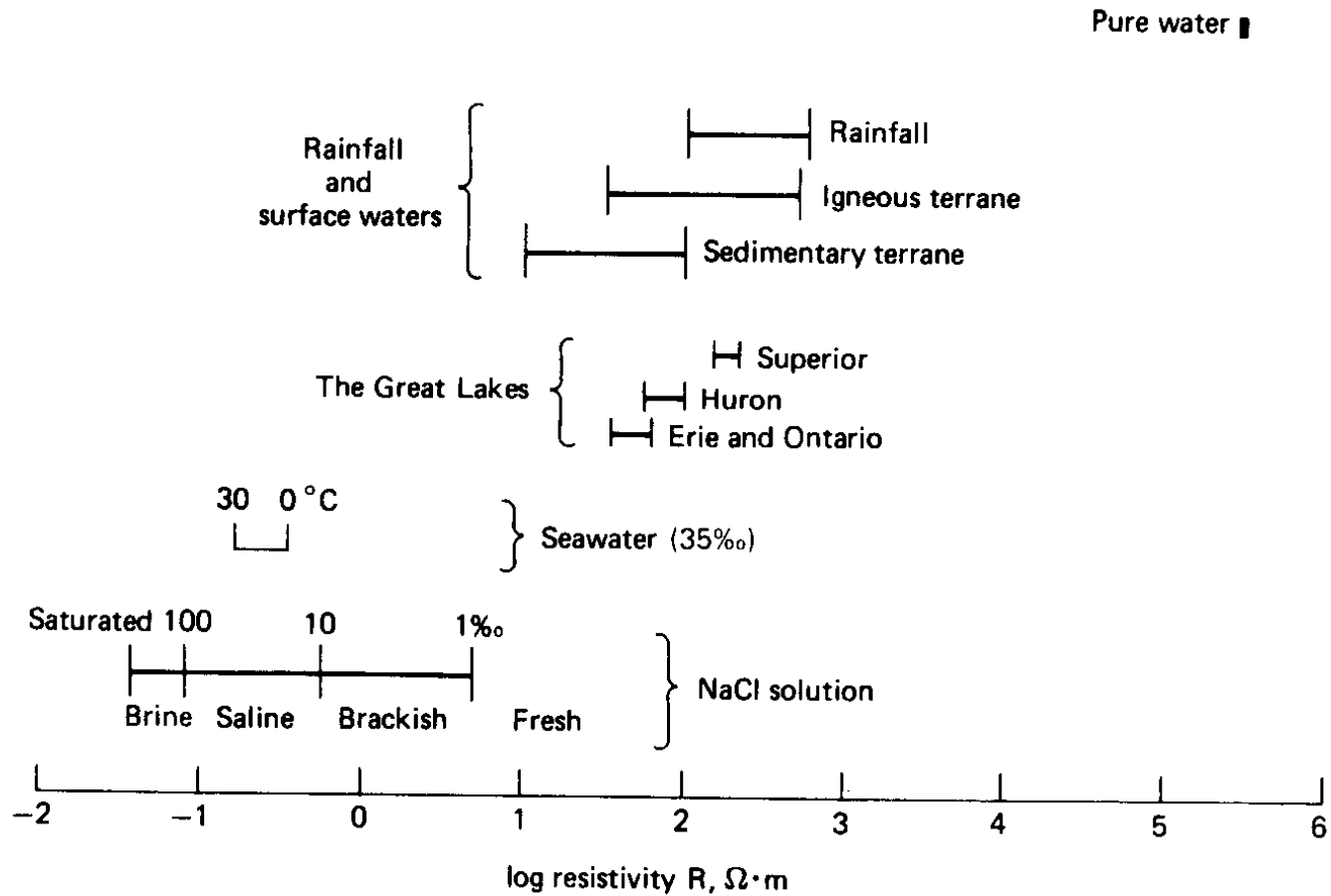
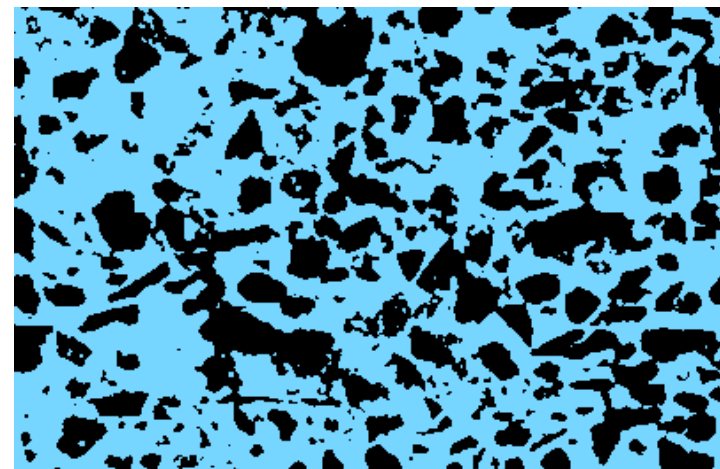
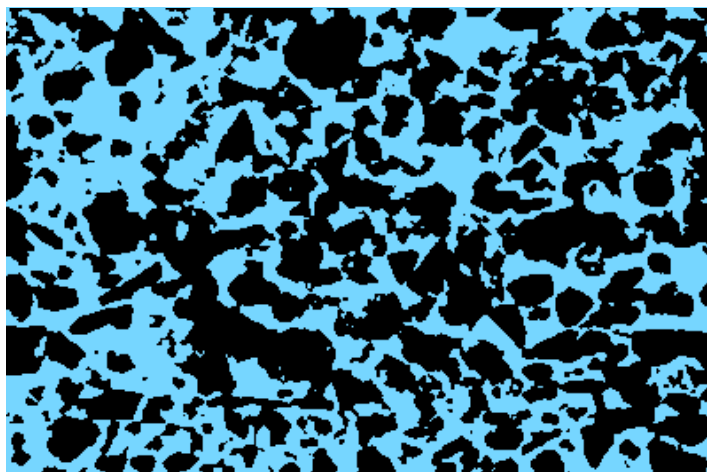

Figure 5.2 Range of resistivity values of pure and natural waters. (Data sources: pure water, Dorsey, 1940; rainfall, Sarma and Rao, 1972; Great Lakes, Doherty, 1963; NaCl, Schlumberger, 1972; all other information, Freeze and Cherry, 1979)



Water



Resistivity

Porosity

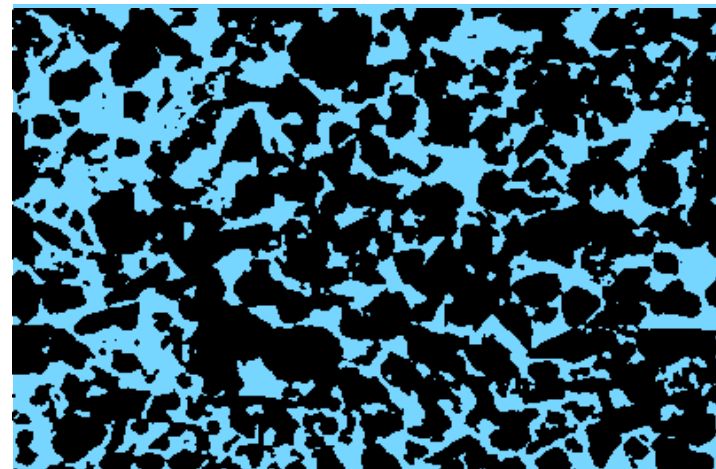

Archie's equation (I)

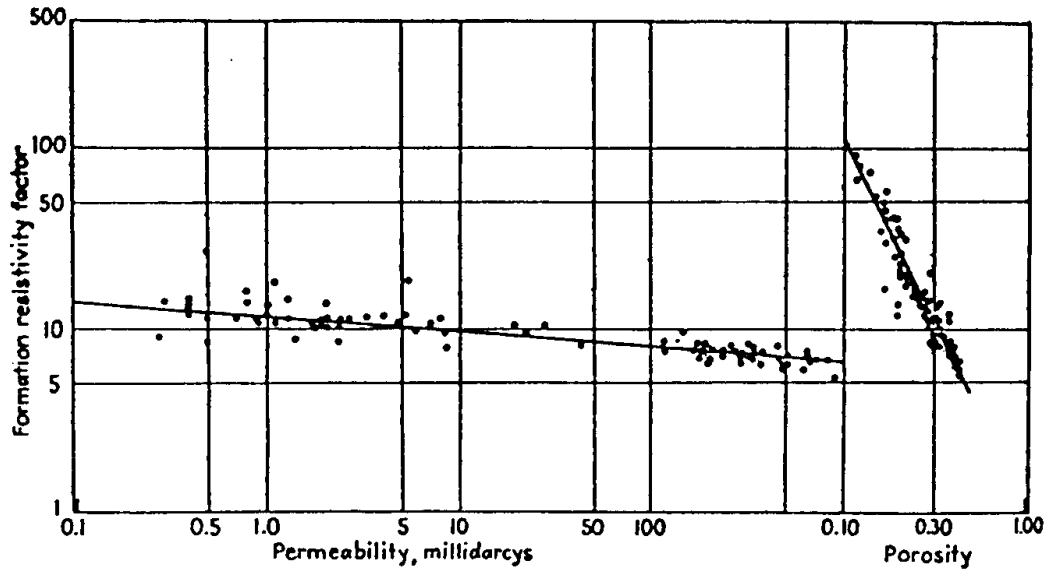

$$R_0 = FR_w = \frac{a R_w}{\phi^m}$$

R_0 Resistivity of fully water-saturated sample

R_w Resistivity of water

F Formation factor > 1

a Tortuosity coefficient ≈ 1

m Cementation exponent ≈ 2

Constant
resistivity

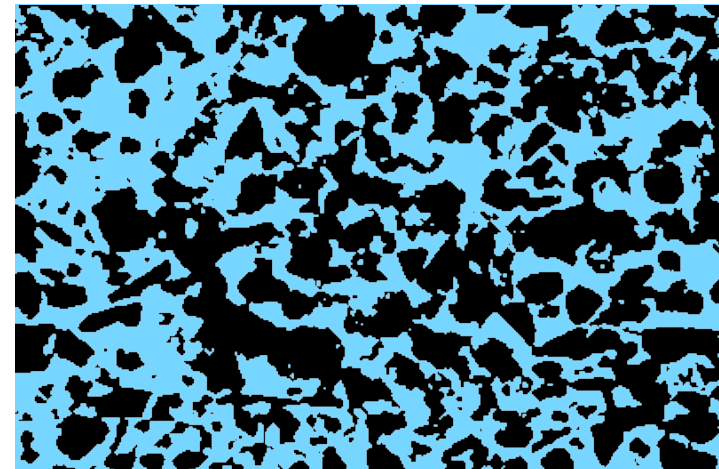
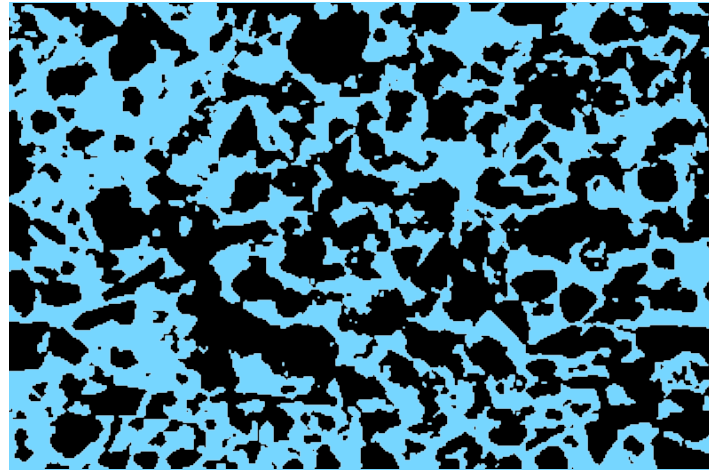

Constant
porosity

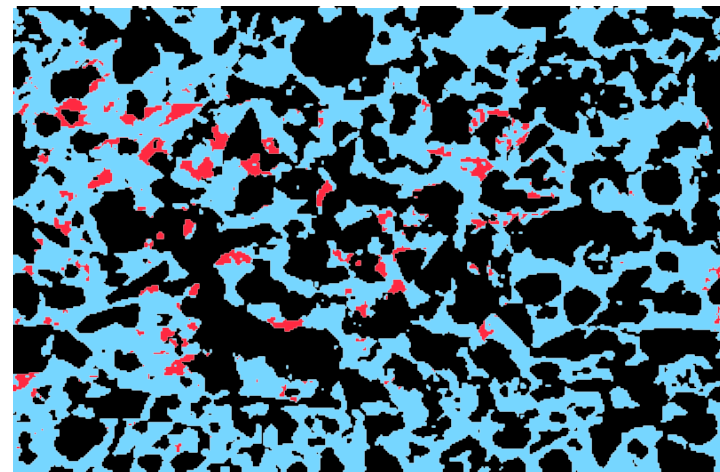

Water

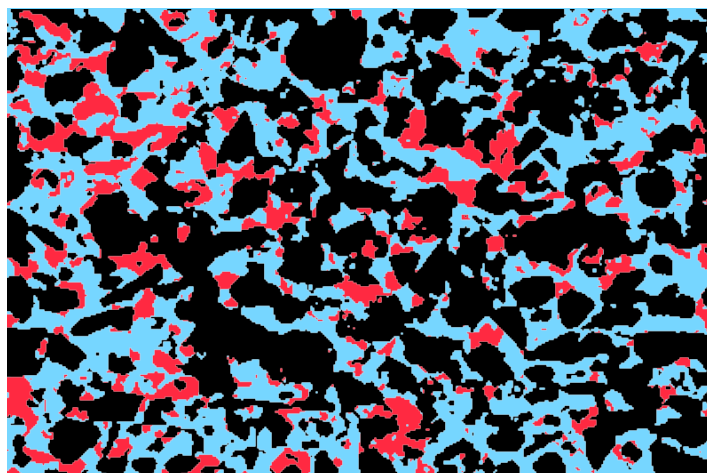

Non-water

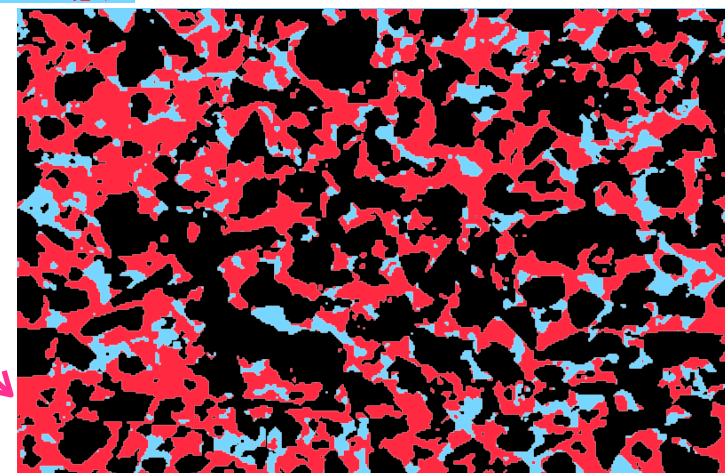

Resistivity

Water saturation

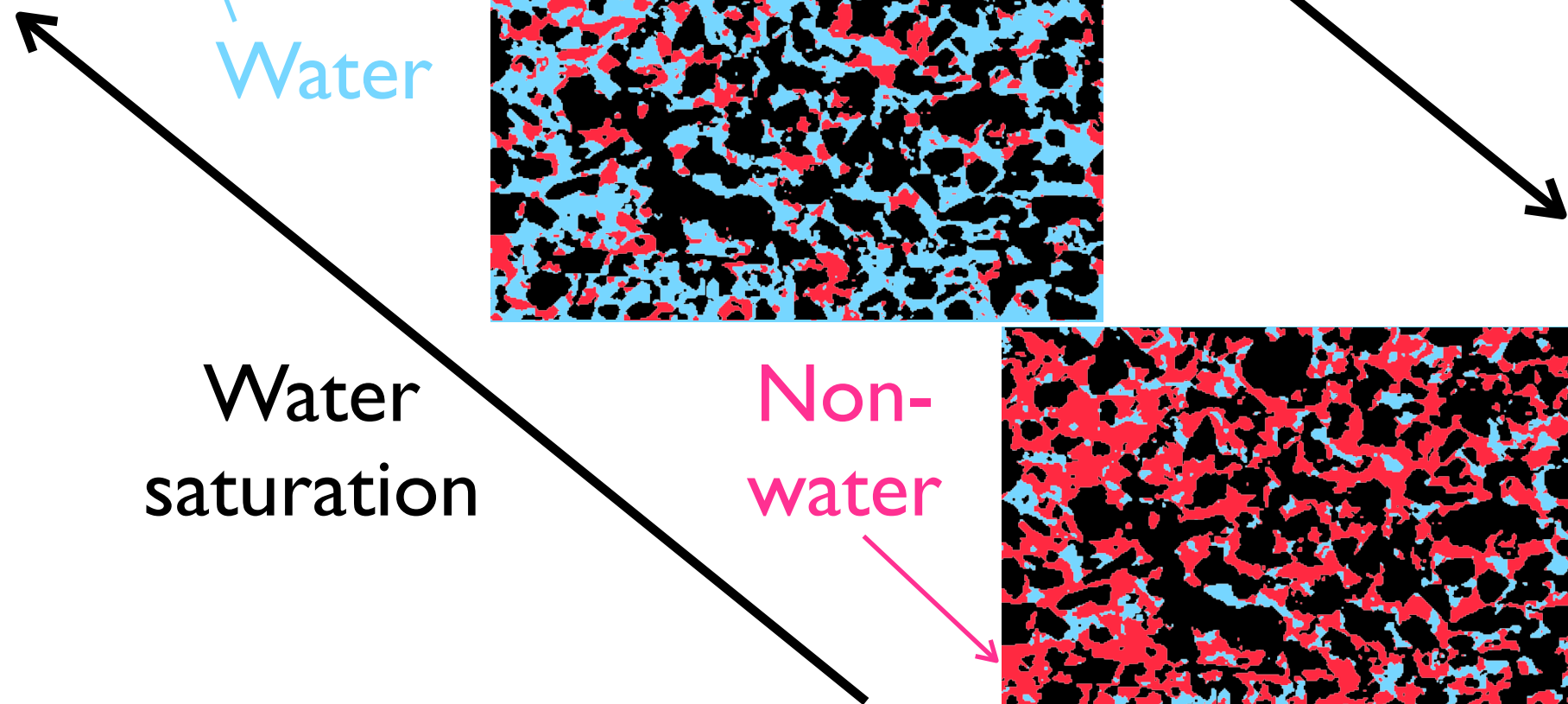

Archie's equation (2)

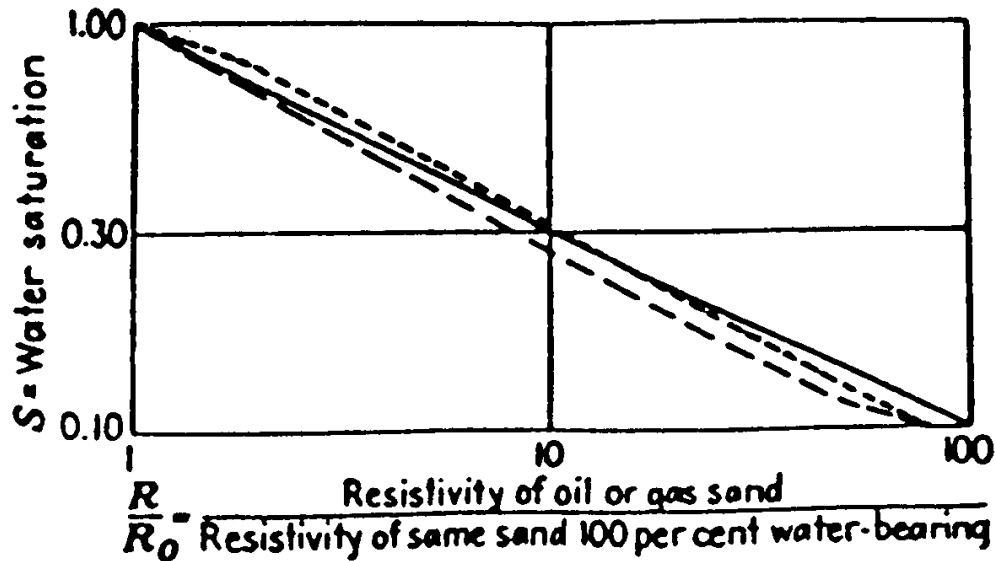

$$R_t = \frac{R_0}{(S_w)^n}$$

R_0 Resistivity of fully water-saturated sample

R_w Resistivity of water

R_t Resistivity of sample

S_w Water saturation of sample

F Formation factor > 1

a Tortuosity coefficient ≈ 1

m Cementation exponent ≈ 2

n Saturation exponent ≈ 2

Archie's equation

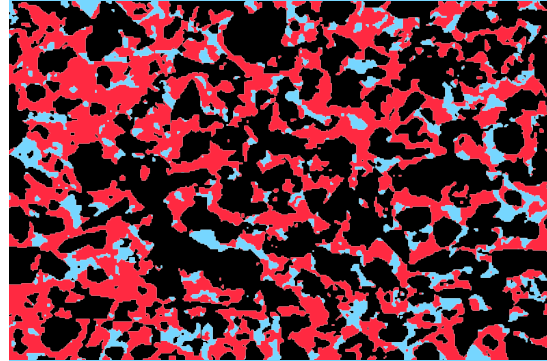
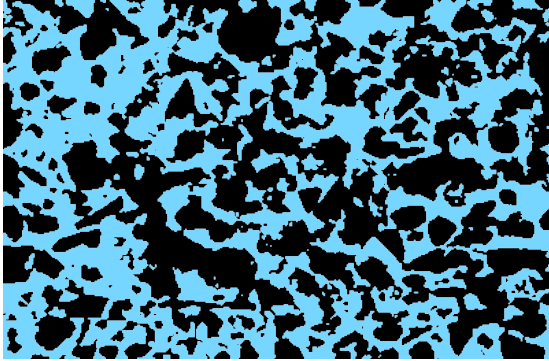

$$S_w = \left[\frac{a R_w}{\phi^m R_t} \right]^{1/n}$$

$$R_0 = \frac{a R_w}{\phi^m} \quad R_t = \frac{R_0}{(S_w)^n}$$

R_0 Resistivity of fully water-saturated sample

R_w Resistivity of water

R_t Resistivity of sample

S_w Water saturation of sample

F Formation factor > 1

a Tortuosity coefficient ≈ 1

m Cementation exponent ≈ 2

n Saturation exponent ≈ 2

Tortuosity

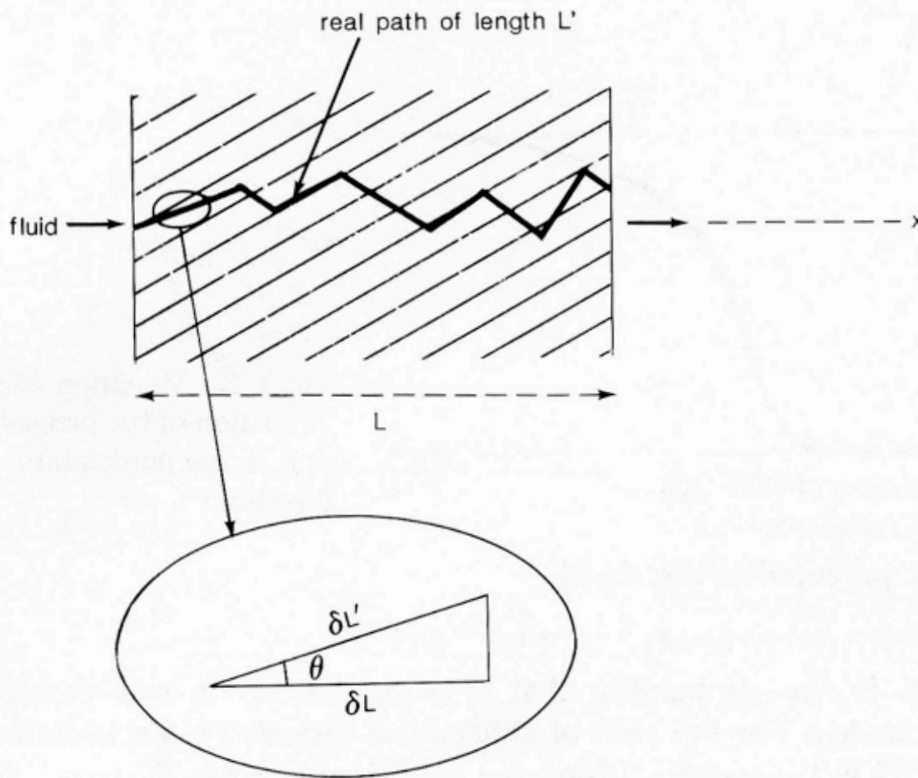

Fig. V.13. Notion of tortuosity: L' is the real flow path of the fluid and L is the apparent path. $\tau = \frac{\delta L'}{\delta L} = \frac{L'}{L}$.

Diffusion coefficient of a dissolved species in sediment:

$$D = \frac{D_0}{\tau^2}$$

where D_0 is the diffusion coefficient in pore water and τ^2 is tortuosity.

By analogy of diffusion and electrical conduction in the pore space,

$$\tau^2 = F\phi = a\phi^{1-m}$$

DETERMINING DIFFUSION COEFFICIENTS IN MARINE SEDIMENTS: A LABORATORY STUDY OF THE VALIDITY OF RESISTIVITY TECHNIQUES

RUSSELL E. McDUFF* and RICK A. ELLIS

Scripps Institution of Oceanography,
University of California, San Diego,
La Jolla, California 92093

ABSTRACT. In principle, sediment diffusion coefficients can be calculated by correcting solution diffusion coefficients with tortuosities deduced from electrical resistivity measurements. The calculation of the solution diffusion coefficient is discussed. Studies of the counterdiffusion of KBr and KCl through inert and ion exchanging porous beds are described. Good agreement between diffusion coefficients obtained by monitoring the chemical composition in the experimental apparatus and those calculated from resistivity measurements is found.

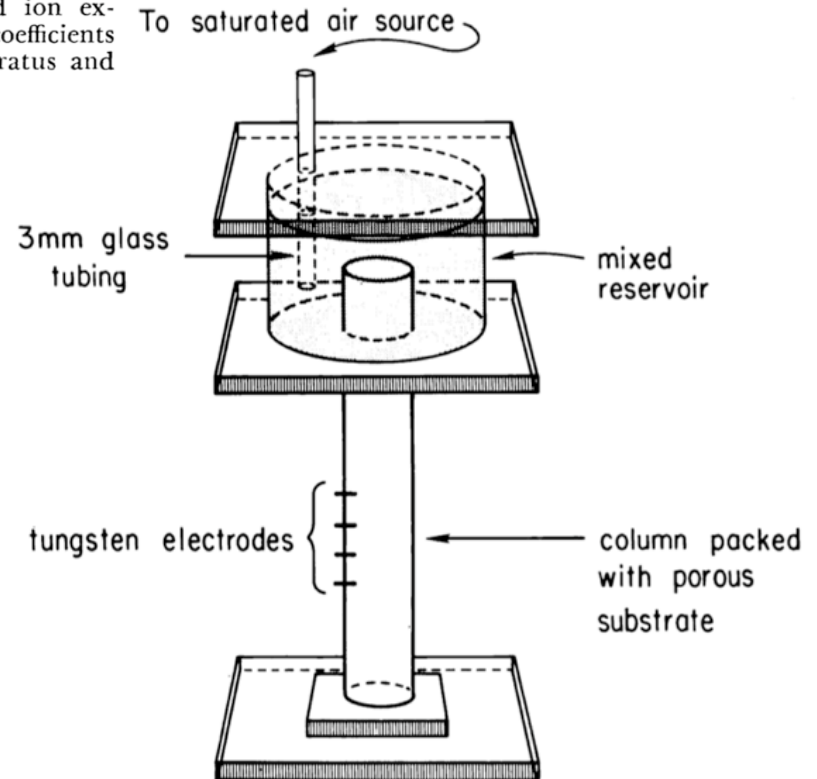
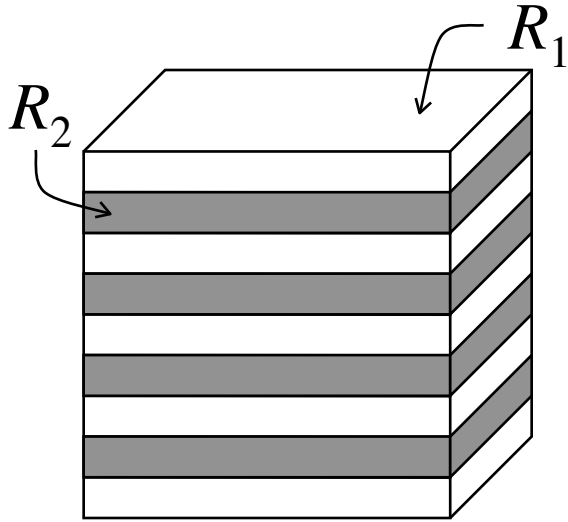

Fig. 2. Apparatus for direct measurement of diffusion coefficients. The appearance of solute from the porous bed is monitored in the upper reservoir which is mixed by a slow stream of water-saturated air. Resistivity measurements are made using the array of four tungsten electrodes. For further details, see text.

Unit Cube



$$R_1 = 1 \Omega \cdot \text{m}$$

$$R_2 = 100 \Omega \cdot \text{m}$$

Horizontal current flow

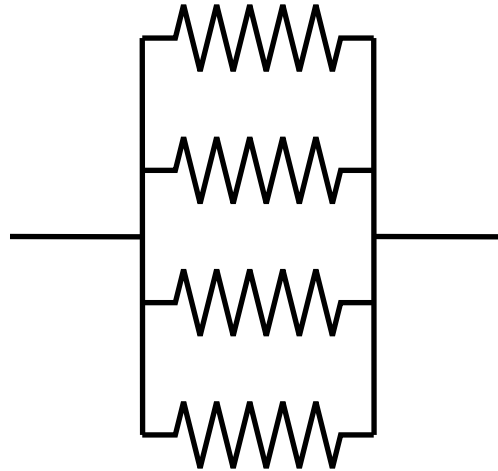

$$R = \left[\frac{1}{2} \left(\frac{1}{R_1} + \frac{1}{R_2} \right) \right]^{-1}$$
$$= \left[\frac{101}{200} \right]^{-1} \approx 2 \Omega \cdot \text{m}$$

Harmonic mean

Vertical current flow



$$R = \frac{1}{2} (R_1 + R_2)$$
$$= \frac{101}{2} \approx 50 \Omega \cdot \text{m}$$

Arithmetic mean

Magnetic susceptibility

- Defined as $\chi = M / H$
 - H = imposed magnetic field
 - M = induced magnetization
- Measures the ease with which sediments are magnetized when subjected to a magnetic field
- Primarily a proxy for concentration of magnetite and other ferromagnetic minerals

Magnetic susceptibility

- Useful as a “terrigenous sediment proxy” in some regions

Eastern equatorial
Atlantic Site 661

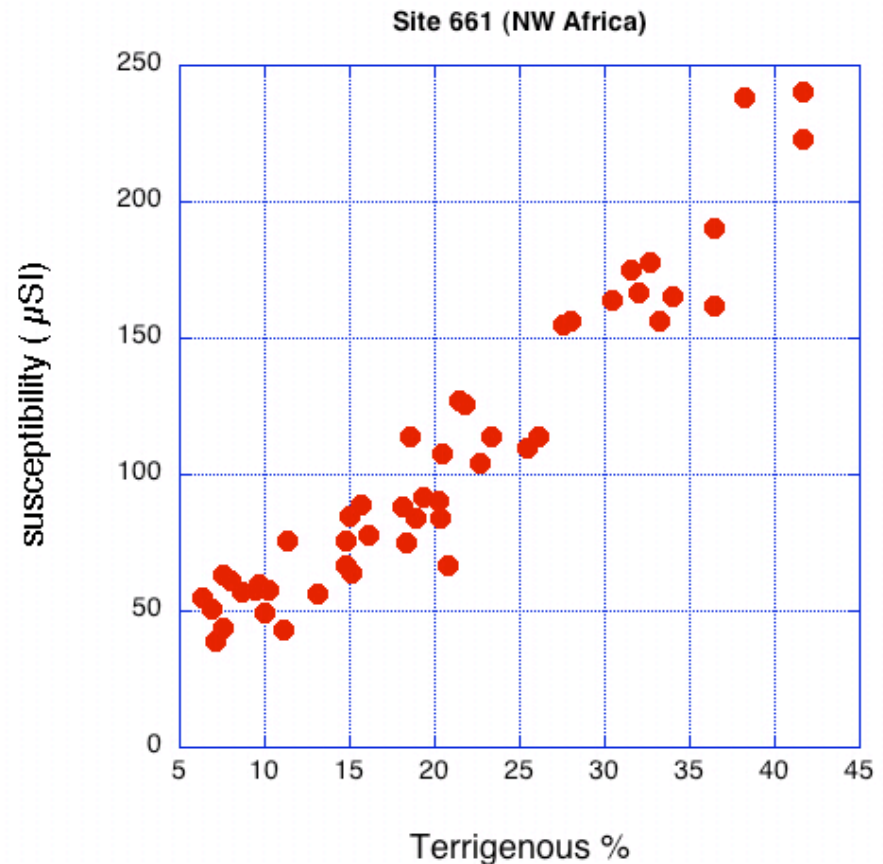

Spectral (color) reflectance

- Digital color reflectance scanner
 - Multichannel, high-precision
 - High-resolution sampling
 - Monitors lightness and wavelength of reflected light source
- Measurements
 - Brightness
 - Red / blue ratio



Predicted CaCO_3 from color reflectance

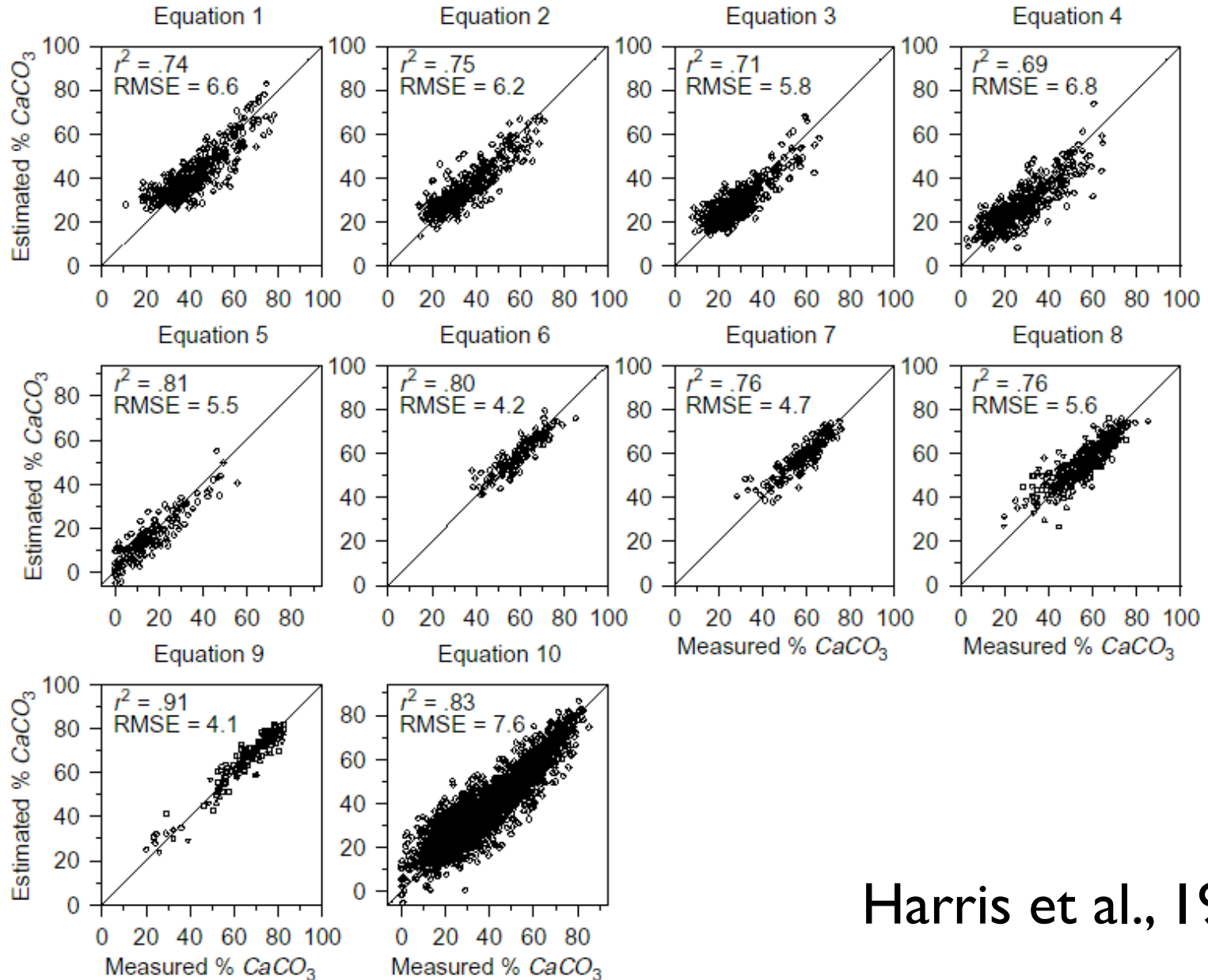

Harris et al., 1997

Predicted mineralogy from color reflectance

Amazon basin terrigenous supply to Ceara Rise

Variability of terrigenous tracer minerals (goethite, hematite)

Harris and Mix, 1999

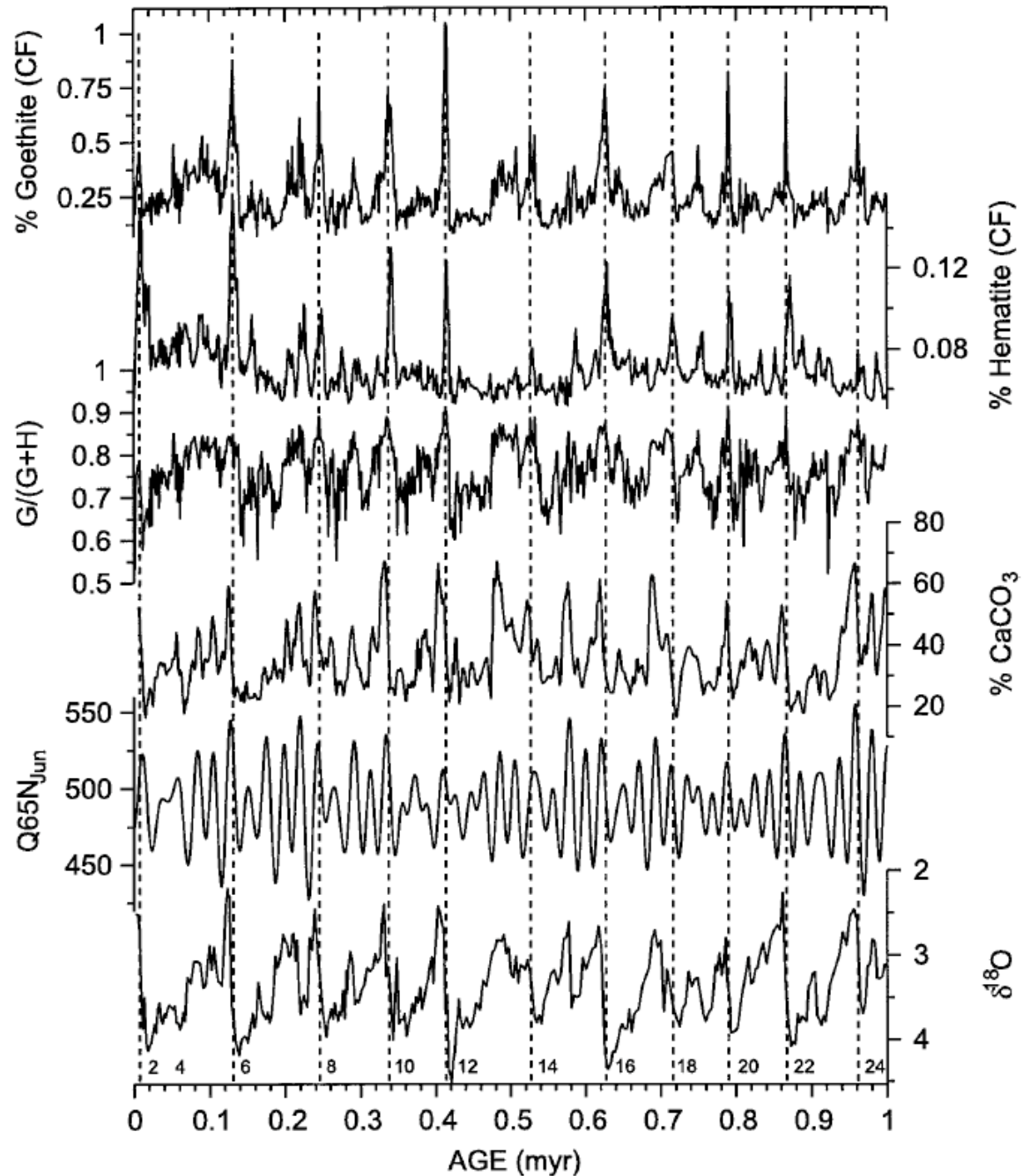

Elastic properties

- Compressional (P) wave velocity
 - Related to sediment rigidity (grain-to-grain contact)
 - Hence density, porosity, compaction, cementation
- Typical values
 - Seawater: 1500 m/s
 - Unconsolidated sediments (at or near the seafloor): 1500-1800 m/s
 - Consolidated sediments: 1800-2500 m/s

P-wave velocity measurement

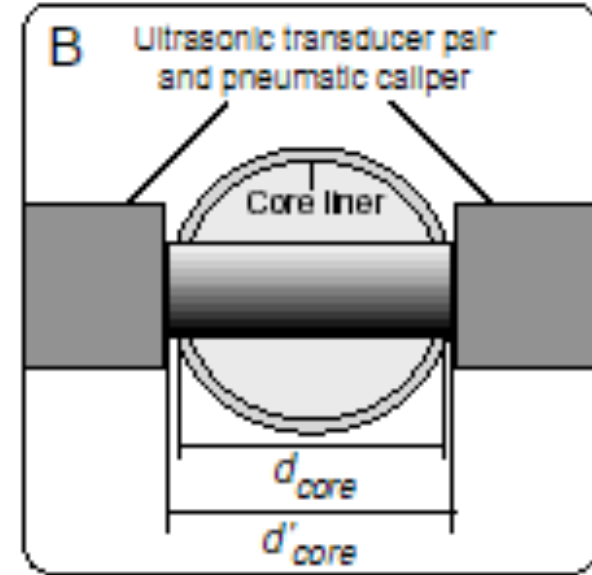
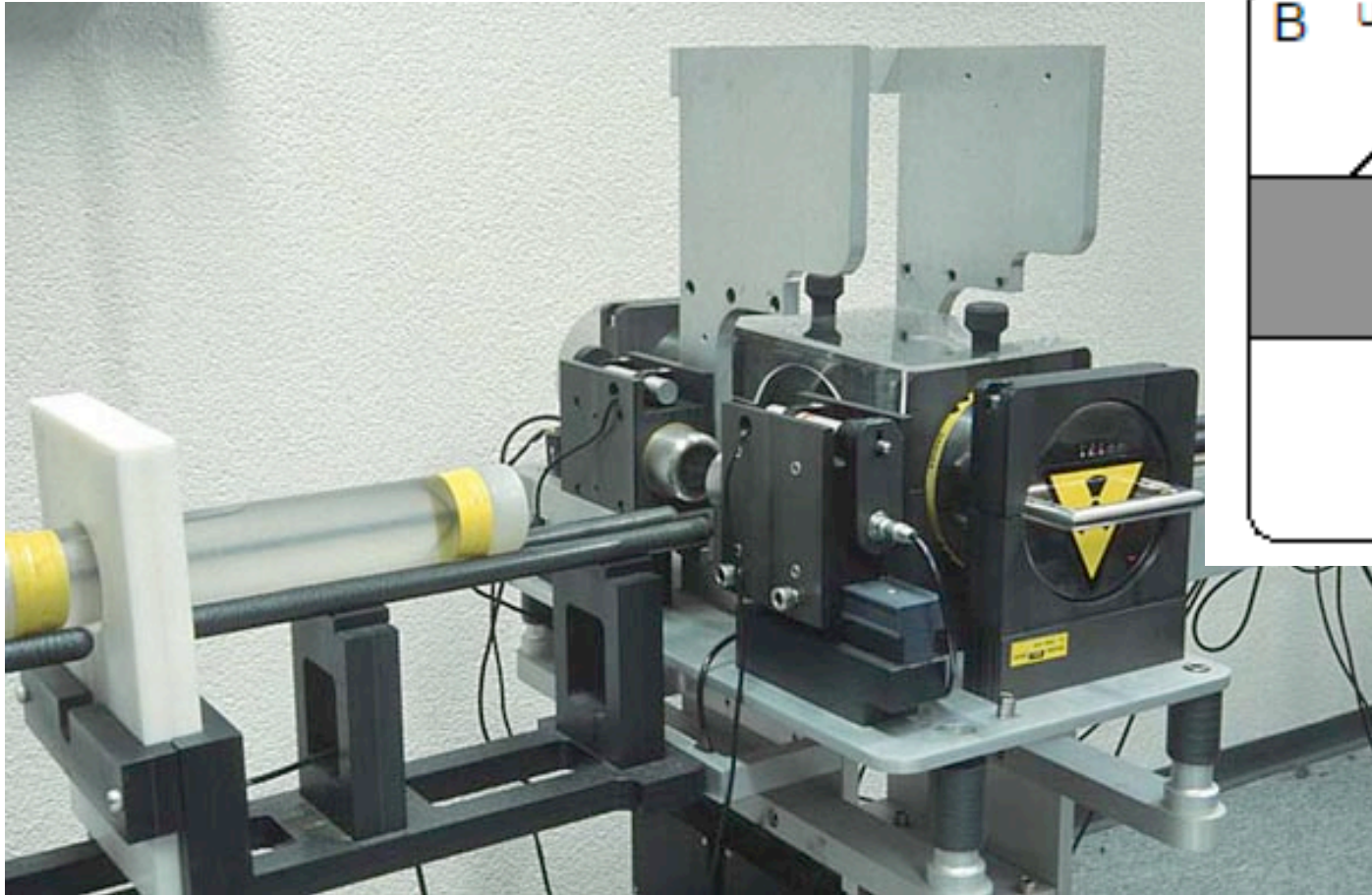

Transducer-receiver 500 kHz 2 μ sec pulse

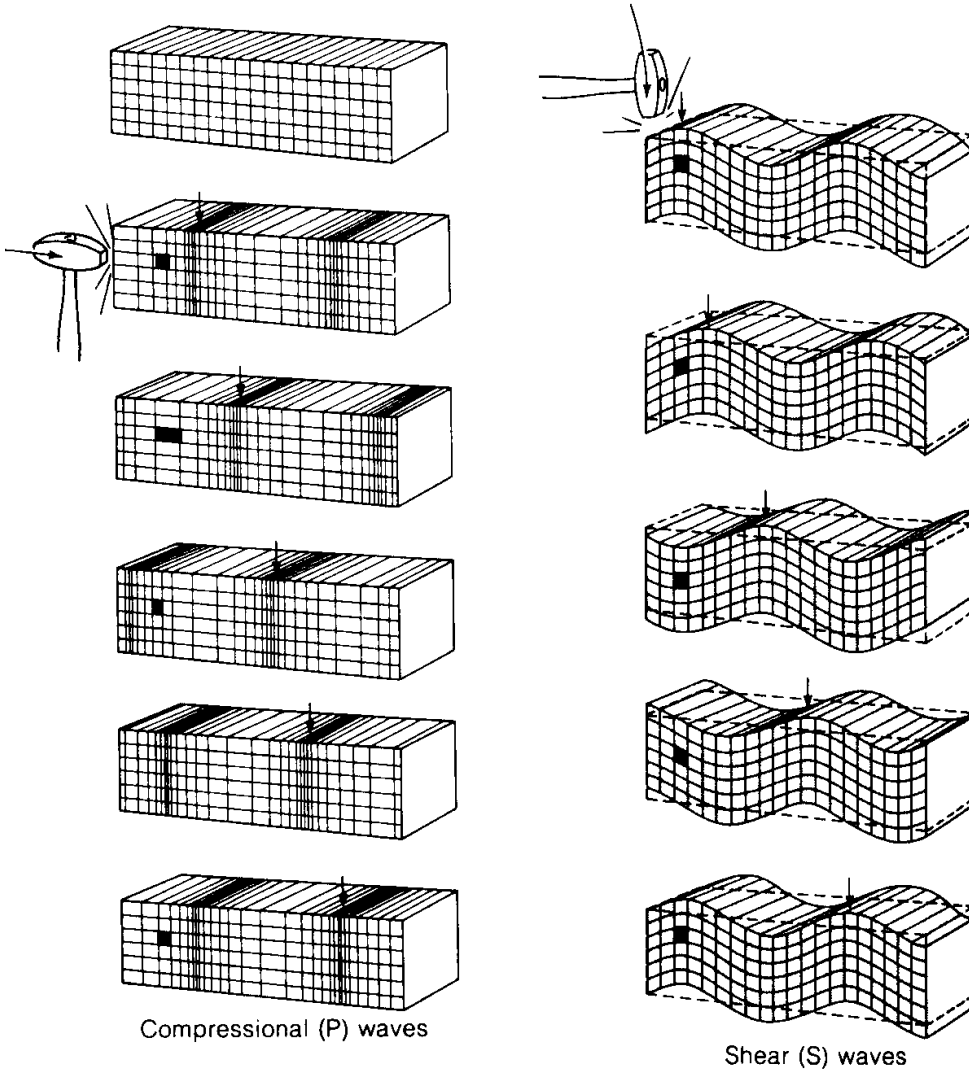

$$V_P = \sqrt{\frac{K + \frac{4}{3}\mu}{\rho}} \quad V_S = \sqrt{\frac{\mu}{\rho}}$$

Bulk modulus K relates compressional stress and strain

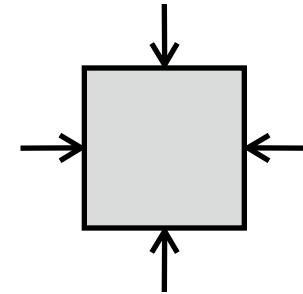

Shear modulus μ relates shear stress and strain



Table VII.4. BASIC RELATIONS BETWEEN ACOUSTIC, ELASTIC, AND MICROSTRUCTURAL PARAMETERS OF A POROUS MEDIUM

	<i>Porous Medium without Fluid</i>	<i>Porous Medium with Fluid</i>
Bulk Modulus	$K = K_s \left(1 - \beta \frac{\phi}{A}\right)$	$K_u = K + \frac{K_f \left(1 - \frac{K}{K_s}\right)^2}{\phi + \left(1 - \frac{K}{K_s} - \phi\right) \frac{K_f}{K_s}}$
Shear Modulus	$\mu = \mu_s \left(1 - \beta' \frac{\phi}{A}\right)$	$\mu_u = \mu$
Density	$\rho = \rho_s (1 - \phi)$	$\rho' = \rho_s (1 - \phi) + \rho_f \phi$
P = Wave	$V_p = \left(\frac{K + (4/3)\mu}{\rho}\right)^{1/2}$	$V_p = \left(\frac{K_u + (4/3)\mu}{\rho'}\right)^{1/2}$
S-Wave	$V_s = \left(\frac{\mu}{\rho}\right)^{1/2}$	$V_s = \left(\frac{\mu}{\rho'}\right)^{1/2}$

K_s, μ_s Elastic moduli of the rock grains

K_f Bulk modulus of fluid

ρ_s, ρ_f Rock grain and fluid densities

A Pore shape aspect ratio ≤ 1

β, β' ≈ 1